



VISHAY INTERTECHNOLOGY, INC.



RECTIFIERS

SELECTOR GUIDE

RECTIFIERS

- Schottky Rectifiers
- Ultrafast Recovery Rectifiers
- Fast Recovery Rectifiers
- Standard Rectifiers
- ESD Protection Rectifier
- Bridge Rectifiers

SEMICONDUCTORS

RECTIFIERS

Schottky (single, dual)
 Standard, Fast, and Ultra-Fast Recovery
 (single, dual)
 Bridge
 Superectifier®
 Sinterglass Avalanche Diodes

HIGH-POWER DIODES AND THYRISTORS

High-Power Fast-Recovery Diodes
 Phase-Control Thyristors
 Fast Thyristors

SMALL-SIGNAL DIODES

Schottky and Switching (single, dual)
 Tuner/Capacitance (single, dual)
 Bandswitching
 PIN

ZENER AND SUPPRESSOR DIODES

Zener (single, dual)
 TVS (TRANSZORB®, Automotive, ESD, Arrays)

FETs

Low-Voltage TrenchFET® Power MOSFETs
 High-Voltage TrenchFET® Power MOSFETs
 High-Voltage Planar MOSFETs
 JFETs

RF TRANSISTORS

Bipolar Transistors (AF and RF)
 Dual Gate MOSFETs
 MOSMICs®

OPTOELECTRONICS

IR Emitters and Detectors,
 and IR Receiver Modules
 Optocouplers and Solid-State Relays
 Optical Sensors
 LEDs and 7-Segment Displays
 Infrared Data Transceiver Modules
 Custom Products

ICs

Power ICs
 Analog Switches
 RF Transceivers and Receiver Modules
 ICs for Optoelectronics

MODULES AND ASSEMBLIES

Automotive Modules and Assemblies
 Power Modules (contain power diodes,
 thyristors, MOSFETs, IGBTs)
 DC/DC Converters

PASSIVE COMPONENTS

RESISTIVE PRODUCTS

Foil Resistors
 Film Resistors
 Metal Film Resistors
 Thin Film Resistors
 Thick Film Resistors
 Metal Oxide Film Resistors
 Carbon Film Resistors
 Wirewound Resistors
 Power Metal Strip® Resistors
 Chip Fuses
 Variable Resistors
 Cermet Variable Resistors
 Wirewound Variable Resistors
 Conductive Plastic Variable Resistors
 Networks/Arrays
 Non-Linear Resistors
 NTC Thermistors
 PTC Thermistors
 Varistors

MAGNETICS

Inductors
 Transformers

CAPACITORS

Tantalum Capacitors
 Molded Chip Tantalum Capacitors
 Coated Chip Tantalum Capacitors
 Solid Through-Hole Tantalum Capacitors
 Wet Tantalum Capacitors
 Ceramic Capacitors
 Multilayer Chip Capacitors
 Disc Capacitors
 Film Capacitors
 Power Capacitors
 Heavy-Current Capacitors
 Aluminum Capacitors
 Silicon RF Capacitors

STRAIN GAGE TRANSDUCERS AND STRESS ANALYSIS SYSTEMS

PhotoStress®
 Strain Gages
 Load Cells
 Force Transducers
 Instruments
 Weighing Systems
 Specialized Strain Gage Systems

Rectifiers

Vishay Intertechnology, Inc.

63 Lancaster Avenue
Malvern, PA 19355
United States
Phone: +1 610 644 1300
Fax: +1 610 296 0657

www.vishay.com

NOTICE Specifications of the products displayed herein are subject to change without notice. Vishay Intertechnology, Inc., or anyone on its behalf, assumes no responsibility or liability for any errors or inaccuracies. Information contained herein is intended to provide a product description only. No license, express or implied, by estoppel or otherwise, to any intellectual property rights is granted by this document. Except as provided in Vishay's terms and conditions of sale for such products, Vishay assumes no liability whatsoever, and disclaims any express or implied warranty, relating to sale and/or use of Vishay products including liability or warranties relating to fitness for a particular purpose, merchantability, or infringement of any patent, copyright, or other intellectual property right. The products shown herein are not designed for use in medical, life-saving, or life-sustaining applications. Customers using or selling these products for use in such applications do so at their own risk and agree to fully indemnify Vishay for any damages resulting from such improper use or sale.



Table of Contents

Schottky Rectifiers	4
Ultrafast Recovery Rectifiers	9
Fast Recovery Rectifiers	13
Standard Rectifiers	15
ESD Protection Rectifier	17
Bridge Rectifiers	18
Rectifier Packages	20
Sample Package Construction	21



Schottky Rectifiers

Schottky Rectifiers are the ideal product for high-speed and low power loss applications. Their metal-silicon junctions and majority carrier condition result in extremely fast recovery times (less than 10 ns) and very low forward voltage drops. Vishay's unique sputtered metallization process and ion implanted guarding technology result in a highly reliable Schottky product. We offer our customers the opportunity to select the best device for their applications by providing the flexibility of different barrier heights.

TMBS™ (Trench MOS Barrier Schottky) Rectifiers

I _{F(AV)} (A)	Device ⁽¹⁾	Source ⁽³⁾	Package		V _(BR) Range (V)	Max V _F @ I _F	
			Family ⁽³⁾	Type		(V)	(A)
8	V8P10	G	Plastic SMD	TO-277A (SMPC)	100	0.68	8
10	V10P10	G	Plastic SMD	TO-277A (SMPC)	100	0.68	10
12	V12P10	G	Plastic SMD	TO-277A (SMPC)	100	0.70	12
20	V20100S	G	Plastic Power Pack	TO-220AB	100	0.85	20
	VB20100S	G	Power Pack SMD	TO-263AB (D ² PAK)	100	0.85	20
	VF20100S	G	Isolated Power Pack	ITO-220AB	100	0.85	20
	VI20100S	G	Plastic Power Pack	TO-262AA	100	0.85	20
	V20100SG	G	Plastic Power Pack	TO-220AB	100	0.97	20
	VF20100SG	G	Isolated Power Pack	ITO-220AB	100	0.97	20
	VI20100SG	G	Plastic Power Pack	TO-262AA	100	0.97	20
	V20120S	G	Plastic Power Pack	TO-220AB	120	1.03	20
	VF20120S	G	Isolated Power Pack	ITO-220AB	120	1.03	20
	VI20120S	G	Plastic Power Pack	TO-262AA	120	1.03	20
	V20120SG	G	Plastic Power Pack	TO-220AB	120	1.23	20
	VF20120SG	G	Isolated Power Pack	ITO-220AB	120	1.23	20
	V20100C	G	Plastic Power Pack	TO-220AB	100	0.70	10
	VI20100C	G	Plastic Power Pack	TO-262AA	100	0.70	10
30	V30100C	G	Plastic Power Pack ⁽²⁾	TO-220AB	100	0.80	15
	V30100S	G	Plastic Power Pack	TO-220AB	100	0.85	30
	VI30100S	G	Plastic Power Pack	TO-262AA	100	0.85	30
	VF30100S	G	Isolated Power Pack	ITO-220AB	100	0.85	30
	VB30100S	G	Power Pack SMD	TO-263AB (D ² PAK)	100	0.85	30
	V30100SG	G	Plastic Power Pack	TO-220AB	100	0.97	30
	VF30100SG	G	Isolated Power Pack	ITO-220AB	100	0.97	30
	VB30100SG	G	Power Pack SMD	TO-263AB (D ² PAK)	100	0.97	30
	VI30100SG	G	Plastic Power Pack	TO-262AA	100	0.97	30
	V30120S	G	Plastic Power Pack	TO-220AB	120	0.95	30
	V30200C	G	Plastic Power Pack ⁽²⁾	TO-220AB	200	0.95	15
	VB30200C	G	Power Pack SMD ⁽²⁾	TO-263AB (D ² PAK)	200	0.95	15
	VI30200C	G	Plastic Power Pack ⁽²⁾	TO-262AA	200	0.95	15
	V30100P	G	Plastic Power Pack ⁽²⁾	TO-247AD (TO-3P)	100	0.85	15
40	VTS40100CT	G	Plastic Power Pack ⁽²⁾	TO-220AB	100	0.76	20
	VF40100C	G	Isolated Power Pack ⁽²⁾	ITO-220AB	100	0.76	20
	VB40100C	G	Power Pack SMD ⁽²⁾	TO-263AB (D ² PAK)	100	0.76	20
	VI40100C	G	Plastic Power Pack	TO-262AA	100	0.76	20
	V40100G	G	Plastic Power Pack ⁽²⁾	TO-220AB	100	0.81	20
	VB40100G	G	Power Pack SMD ⁽²⁾	TO-263AB (D ² PAK)	100	0.81	20
	VI40100G	G	Plastic Power Pack	TO-262AA	100	0.81	20
	V40120C	G	Plastic Power Pack ⁽²⁾	TO-220AB	120	0.86	20
	VB40120C	G	Power Pack SMD ⁽²⁾	TO-263AB (D ² PAK)	120	0.86	20
	VI40120C	G	Plastic Power Pack	TO-262AA	120	0.86	20
	V40100P	G	Plastic Power Pack ⁽²⁾	TO-247AD (TO-3P)	100	0.73	20
	V40100PG	G	Plastic Power Pack ⁽²⁾	TO-247AD (TO-3P)	100	0.80	20

Notes:

(1) **Bold Text** = New Products

(2) Dual center-tapped device (V_F limit @ I_F is per leg)

(3) Source: G = Formerly General Semiconductor®

T = Formerly Vishay Telefunken® (Telefunken® is a registered trademark of Electro Holding GMBH)

→ = Transferred

www.vishay.com



Rectifiers Selector Guide

Schottky Rectifiers

I _{F(AV)} (A)	Device ⁽¹⁾	Source ⁽³⁾	Package		V _(BR) Range (V)	Max V _F @ I _F	
			Family ⁽³⁾	Type		(V)	(A)
50	V50100P	G	Plastic Power Pack ⁽²⁾	TO-247AD (TO-3P)	100	0.78	25
60	V60100C	G	Plastic Power Pack ⁽²⁾	TO-220AB	100	0.66	30
	V60120C	G	Plastic Power Pack ⁽²⁾	TO-220AB	120	0.95	30
	V60100P	G	Plastic Power Pack ⁽²⁾	TO-247AD (TO-3P)	100	0.79	30
80	V80100P	G	Plastic Power Pack ⁽²⁾	TO-247AD (TO-3P)	100	0.78	40

Notes:

(1) **Bold Text** = New Products

(2) Dual center-tapped device (V_F limit @ I_F is per leg)

(3) Source: G = Formerly General Semiconductor[®]

T = Formerly Vishay Telefunken[®] (Telefunken[®] is a registered trademark of Electro Holding GMBH)

→ = Transferred

I _{F(AV)} (A)	Device ⁽¹⁾	Source ⁽⁵⁾	Package		V _(BR) Range (V)	Max V _F @ I _F	
			Family ⁽³⁾	Type		(V)	(A)
0.5	MBR0520L	G → T	Plastic SMD	SOD-123	20	0.385	0.5
	MBR0530	G → T	Plastic SMD	SOD-123	30	0.43	0.5
	MBR0540	G → T	Plastic SMD	SOD-123	40	0.51	0.5
0.6	SB020 - SB060	G	Plastic Axial	MPG06	20 - 60	0.55 / 0.70	0.6
1.0	1N5817 - 1N5819	G	Plastic Axial	DO-204AL (DO-41)	20 - 40	0.45 - 0.60	1.0
	BYM13-xx	G	Plastic SMD	DO-213AB (MELF)	20 - 60	0.50 - 0.70	1.0
	MSS1P2L - MSS1P3L	G	Plastic SMD	MicroSMP	20 - 30	0.50	1.0
	MSS1P3 - MSS1P4	G	Plastic SMD	MicroSMP	30 - 40	0.55	1.0
	MSS1P5 - MSS1P6	G	Plastic SMD	MicroSMP	50 - 60	0.68	1.0
	SB120 - SB160	G	Plastic Axial	DO-204AL (DO-41)	20 - 60	0.48 - 0.65	1.0
	SB120A - SB160A	G	Plastic Axial	DO-204AL (DO-41)	20 - 60	0.50 - 0.70	1.0
	SB1H90 - SB1H100	G	Plastic Axial	DO-204AL (DO-41)	90 - 100	0.77	1.0
	SGL41-xx	G	Plastic SMD	DO-213AB (MELF)	20 - 60	0.50 - 0.70	1.0
	SS12 - SS16	G	Plastic SMD	DO-214AC (SMA)	20 - 60	0.50 - 0.75	1.0
	B120 - B160	G	Plastic SMD	DO-214AC (SMA)	20 - 60	0.52 - 0.75	1.0
	SS1H9 - SS1H10	G	Plastic SMD	DO-214AC (SMA)	90 - 100	0.77	1.0
	SS1P3L - SS1P4L	G	Plastic SMD	DO-220AA (SMP)	30 - 40	0.45 - 0.48	1.0
SS1P3 - SS1P4	G	Plastic SMD	DO-220AA (SMP)	30 - 40	0.50 - 0.53	1.0	
1.1	SL02 - SL04	G → T	Plastic SMD	DO-219 (SMF)	20 - 40	0.41 / 0.45 / 0.53	1.1
1.5	BYS10-xx	T → G	Plastic SMD	DO-214AC (SMA)	25 - 45	0.5	1.0
	BYS11-90	T → G	Plastic SMD	DO-214AC (SMA)	90	0.9	1.0
	BYS12-90	T → G	Plastic SMD	DO-214AC (SMA)	90	0.75	1.0
	SL12 - SL13	G	Plastic SMD	DO-214AC (SMA)	20 - 30	0.36 / 0.445	0.1 / 1.0
	SS29 - SS210	G	Plastic SMD	DO-214AA(SMB)	90 - 100	0.75	1.0
2.0	SB220 - SB260	G	Plastic Axial	DO-204AC (DO-15)	20 - 60	0.5 / 0.68	2.0
	SB220S - SB260S	G	Plastic Axial	DO-204AL (DO-41)	20 - 60	0.55 / 0.70	2.0
	SB2H90 - SB2H100	G	Plastic Axial	DO-204AC (DO-15)	90 - 100	0.79	2.0
	B230LA & B240A	G	Plastic SMD	DO-214AC (SMA)	20 - 60	0.50 - 0.55	2.0
	SL22 - SL23	G	Plastic SMD	DO-214AA (SMB)	20 - 30	0.395 / 0.44	1.0 / 2.0
	SS22 - SS26	G	Plastic SMD	DO-214AA (SMB)	20 - 60	0.50 - 0.75	2.0
	SS22S - SS24S	G	Plastic SMD	DO-214AA (SMB)	20 - 40	0.55	2.0
	SS2H9 - SS2H10	G	Plastic SMD	DO-214AA (SMB)	90 - 100	0.79	2.0
	SS2P2 - SS2P4	G	Plastic SMD	DO-220AA (SMP)	20 - 40	0.55	2.0
	SS2P2L - SS2P3L	G	Plastic SMD	DO-220AA (SMP)	20 - 30	0.50	2.0
	SS2P5 - SS2P6	G	Plastic SMD	DO-220AA (SMP)	50 - 60	0.70	2.0
	SS2PH9 - SS2PH10	G	Plastic SMD	DO-220AA (SMP)	90 - 100	0.80	2.0
	SSA23L & SSA24	G	Plastic SMD	DO-214AC (SMA)	30 - 40	0.45 - 0.49	2.0

Notes:

(1) **Bold Text** = New Products

(2) Dual center-tapped device (V_F limit @ I_F is per leg)

(3) All Schottky die are planar with oxide passivation

(4) 35 V - 45 V product / 50 V - 60 V product

(5) Source: G = Formerly General Semiconductor[®]

T = Formerly Vishay Telefunken[®] (Telefunken[®] is a registered trademark of Electro Holding GMBH)

→ = Transferred

Rectifiers Selector Guide



Schottky Rectifiers

I _{F(AV)} (A)	Device ⁽¹⁾	Source ⁽⁵⁾	Package		V _(BR) Range (V)	Max V _F @ I _F	
			Family ⁽³⁾	Type		(V)	(A)
3.0	B330LA & B340A	G	Plastic SMD	DO-214AC (SMA)	20 - 60	0.50 - 0.55	3.0
	1N5820 - 1N5822	G	Plastic Axial	DO-201AD	20 - 40	0.475 - 0.525	3.0
	SB320 - SB360	G	Plastic Axial	DO-201AD	20 - 60	0.49 - 0.68	3.0
	SB320A - SB360A	G	Plastic Axial	DO-201 AD	20 - 60	0.50 / 0.70	3.0
	SB320S - SB360S	G	Plastic Axial	DO-204AC (DO-15)	20 - 60	0.50 - 0.70	3.0
	SB3H90 - SB3H100	G	Plastic Axial	DO-201AD	90 - 100	0.8	3.0
	SS32 - SS36	G	Plastic SMD	DO-214AB (SMC)	20 - 60	0.5 - 0.75	3.0
	SS3H9 - SS3H10	G	Plastic SMD	DO-214AB (SMC)	90 - 100	0.8	3.0
	SS3P3	G	Plastic SMD	DO-220AA (SMP)	30	0.58	3.0
	SS3P4	G	Plastic SMD	DO-220AA (SMP)	40	0.60	3.0
	SS3P5 & SS3P6	G	Plastic SMD	DO-220AA (SMP)	40	0.6	3.0
	SSA33L & SSA34	G	Plastic SMD	DO-214AC (SMA)	30 - 40	0.45 - 0.49	3.0
	SS3P3L & SS3P4L	G	Plastic SMD	TO-277A (SMPC)	30 - 40	0.47	3.0
SS3P5L & SS3P6L	G	Plastic SMD	TO-277A (SMPC)	50 - 60	0.60	3.0	
4.0	SL42 - SL43	G	Plastic SMD	DO-214AB (SMC)	20 - 30	0.42 / 0.47	4.0 / 8.0
	SL44	G	Plastic SMD	DO-214AB (SMC)	40	0.44 / 0.50	4.0 / 8.0
	SSB43L & SSB44	G	Plastic SMD	DO-214AA (SMB)	30 - 40	0.45 - 0.49	4.0
5.0	SB520 - SB560	G	Plastic Axial	DO-201AD	20 - 60	0.48 - 0.65	5.0
	SB520A - SB560A	G	Plastic Axial	DO-201AD	20 - 60	0.50 - 0.70	5.0
	SB5H90 - SB5H100	G	Plastic Axial	DO-201AD	90 - 100	0.8	5.0
	SSC53L & SSC54	G	Plastic SMD	DO-214AB (SMC)	30 - 40	0.45 - 0.49	5.0
	SS5P3 & SS5P4	G	Plastic SMD	TO-277A (SMPC)	50 - 60	0.52	5.0
	SS5P5 & SS5P6	G	Plastic SMD	TO-277A (SMPC)	50 - 60	0.69	5.0
SS5P9 & SS5P10	G	Plastic SMD	TO-277A (SMPC)	90 - 100	0.88	3.0	
7.5	MBR735 - MBR760	G	Plastic Power Pack	TO-220AC	35 - 60	0.84 / 0.75 ⁽⁴⁾	15 / 7.5
	MBRB735 - MBRB760	G	Power Pack SMD	TO-263AB (D ² PAK)	35 - 60	0.84 / 0.75 ⁽⁴⁾	15 / 7.5
	MBRF735 - MBRF760	G	Isolated Power Pack	ITO-220AC	35 - 60	0.84 / 0.75 ⁽⁴⁾	15 / 7.5
	MBR7H35 - MBR7H60	G	Plastic Power Pack	TO-220AC	35 - 60	0.63 / 0.73 ⁽⁴⁾	7.5
	MBRB7H35 - MBRB7H60	G	Power Pack SMD	TO-263AB (D ² PAK)	35 - 60	0.63 / 0.73 ⁽⁴⁾	7.5
	MBRF7H35 - MBRF7H60	G	Isolated Power Pack	ITO-220AC	35 - 60	0.63 / 0.73 ⁽⁴⁾	7.5
8	SS8P2L & SS8P3L	G	Plastic SMD	TO-277A (SMPC)	20 - 30	0.57	8.0
	SS8PH9 & SS8PH10	G	Plastic SMD	TO-277A (SMPC)	90 - 100	0.89	8.0
	SS8P2CL & SS8P3CL	G	Plastic SMD	TO-277A (SMPC)	20 - 30	0.54	4.0
	SS8P3C & SS8P4C	G	Plastic SMD	TO-277A (SMPC)	30 - 40	0.58	4.0
	SS8P5C & SS8P6C	G	Plastic SMD	TO-277A (SMPC)	50 - 60	0.70	4.0
10	MBR1035 - MBR1060	G	Plastic Power Pack	TO-220AC	35 - 60	0.84 / 0.80 ⁽⁴⁾	20 / 10
	MBRB1035 - MBRB1060	G	Power Pack SMD	TO-263AB (D ² PAK)	35 - 60	0.84 / 0.80 ⁽⁴⁾	20 / 10
	MBRF1035 - MBRF1060	G	Isolated Power Pack	ITO-220AC	35 - 60	0.84 / 0.80 ⁽⁴⁾	20 / 10
	MBR10H35 - MBR10H60	G	Plastic Power Pack	TO-220AC	35 - 60	0.63 / 0.71 ⁽⁴⁾	10
	MBRB10H35 - MBRB10H60	G	Power Pack SMD	TO-263AB (D ² PAK)	35 - 60	0.63 / 0.71 ⁽⁴⁾	10
	MBRF10H35 - MBRF10H60	G	Isolated Power Pack	ITO-220AC	35 - 60	0.63 / 0.71 ⁽⁴⁾	10
	MBR1090 - MBR10100	G	Plastic Power Pack	TO-220AC	90 - 100	0.8	10
	MBRB1090 - MBRB10100	G	Power Pack SMD	TO-263AB (D ² PAK)	90 - 100	0.8	10
	MBRF1090 - MBRF10100	G	Isolated Power Pack	ITO-220AC	90 - 100	0.8	10
	MBR1090CT - MBR10100CT	G	Plastic Power Pack ⁽²⁾	TO-220AB	90 - 100	0.85	5.0
	MBRF1090CT - MBRF10100CT	G	Isolated Power Pack ⁽²⁾	ITO-220AB	90 - 100	0.85	5.0
	MBR10H90 - MBR10H100	G	Plastic Power Pack	TO-220AC	90 - 100	0.77	10
	MBRB10H90 - MBRB10H100	G	Power Pack SMD	TO-263AB (D ² PAK)	90 - 100	0.77	10
MBRF10H90 - MBRF10H100	G	Isolated Power Pack	ITO-220AC	90 - 100	0.77	10	

Notes:

(1) **Bold Text** = New Products

(2) Dual center-tapped device (V_F limit @ I_F is per leg)

(3) All Schottky die are planar with oxide passivation

(4) 35 V - 45 V product / 50 V - 60 V product

(5) Source: G = Formerly General Semiconductor[®]

T = Formerly Vishay Telefunken[®] (Telefunken[®] is a registered trademark of Electro Holding GMBH)

→ = Transferred



I _{F(AV)} (A)	Device ⁽¹⁾	Source ⁽⁵⁾	Package		V _(BR) Range (V)	Max V _F @ I _F	
			Family ⁽³⁾	Type		(V)	(A)
10 (cont'd)	MBR10H90CT - MBR10H100CT	G	Plastic Power Pack ⁽²⁾	TO-220AB	90 - 100	0.76	5.0
	MBRB10H90CT - MBRB10H100CT	G	Power Pack SMD ⁽²⁾	TO-263AB (D ² PAK)	90 - 100	0.76	5.0
	MBRF10H90CT - MBRF10H100CT	G	Isolated Power Pack ⁽²⁾	ITO-220AB	90 - 100	0.76	5.0
	MBR10H150CT	G	Plastic Power Pack ⁽²⁾	TO-220AB	150	0.88	5.0
	SB10H150CT-1	G	Plastic Power Pack ⁽²⁾	TO-262AA	150	0.88	5.0
	MBRF10H150CT	G	Isolated Power Pack ⁽²⁾	ITO-220AB	150	0.88	5.0
	SBL1030 - SBL1040	G	Plastic Power Pack	TO-220AC	30 - 40	0.55	10
	SBLB1030 - SBLB1040	G	Power Pack SMD	TO-263AB (D ² PAK)	30 - 40	0.55	10
	SBLF1030 - SBLF1040	G	Isolated Power Pack	ITO-220AC	30 - 40	0.55	10
	SBL1030CT - SBL1040CT	G	Plastic Power Pack ⁽²⁾	TO-220AB	30 - 40	0.55	5.0
	SBLB1030CT - SBLB1040CT	G	Power Pack SMD ⁽²⁾	TO-263AB (D ² PAK)	30 - 40	0.55	5.0
	SBLF1030CT - SBLF1040CT	G	Isolated Power Pack ⁽²⁾	ITO-220AB	30 - 40	0.55	5.0
	SBL10L25	G	Plastic Power Pack	TO-220AC	25	0.46	10
	SBLB10L25	G	Power Pack SMD	TO-263AB (D ² PAK)	25	0.46	10
	SBLF10L25	G	Isolated Power Pack	ITO-220AC	25	0.46	10
	SBL10L30	G	Plastic Power Pack	TO-220AC	30	0.52	10
	SBLB10L30	G	Power Pack SMD	TO-263AB (D ² PAK)	30	0.52	10
	SBLF10L30	G	Isolated Power Pack	ITO-220AC	30	0.52	10
	SS10P3 - SS10P4	G	Plastic SMD	TO-277A (SMPC)	30 - 40	0.51	10
	SS10P2CL & SS10P3CL	G	Plastic SMD	TO-277A (SMPC)	20 - 30	0.52	5.0
SS10P3C & SS10P4C	G	Plastic SMD	TO-277A (SMPC)	30 - 40	0.53	5.0	
15	MBR1535CT - MBR1560CT	G	Plastic Power-pack ⁽²⁾	TO-220AB	35 - 60	0.84 / 0.75 ⁽⁴⁾	15 / 7.5
	MBRB1535CT - MBRB1560CT	G	Power Pack SMD ⁽²⁾	TO-263AB (D ² PAK)	35 - 60	0.84 / 0.75 ⁽⁴⁾	15 / 7.5
	MBRF1535CT - MBRF1560CT	G	Isolated Power Pack ⁽²⁾	ITO-220AB	35 - 60	0.84 / 0.75 ⁽⁴⁾	15 / 7.5
	MBR15H35CT - MBR15H60CT	G	Plastic Power Pack ⁽²⁾	TO-220AB	35 - 60	0.63 / 0.73 ⁽⁴⁾	7.5
	MBRB15H35CT - MBRB15H60CT	G	Power Pack SMD ⁽²⁾	TO-263AB (D ² PAK)	35 - 60	0.63 / 0.73 ⁽⁴⁾	7.5
	MBRF15H35CT - MBRF15H60CT	G	Isolated Power Pack ⁽²⁾	ITO-220AB	35 - 60	0.63 / 0.73 ⁽⁴⁾	7.5
16	MBR1635 - MBR1660	G	Plastic Power Pack	TO-220AC	35 - 60	0.63 / 0.75 ⁽⁴⁾	16
	MBRB1635 - MBRB1660	G	Power Pack SMD	TO-263AB (D ² PAK)	35 - 60	0.63 / 0.75 ⁽⁴⁾	16
	MBRF1635 - MBRF1660	G	Isolated Power Pack	ITO-220AC	35 - 60	0.63 / 0.75 ⁽⁴⁾	16
	MBR16H35 - MBR16H60	G	Plastic Power Pack	TO-220AC	35 - 60	0.66 / 0.73 ⁽⁴⁾	16
	MBRB16H35 - MBRB16H60	G	Power Pack SMD	TO-263AB (D ² PAK)	35 - 60	0.66 / 0.73 ⁽⁴⁾	16
	MBRF16H35 - MBRF16H60	G	Isolated Power Pack	ITO-220AC	35 - 60	0.66 / 0.73 ⁽⁴⁾	16
	SBL1630CT - SBL1640CT	G	Plastic Power Pack ⁽²⁾	TO-220AB	30 - 40	0.55	8.0
	SBLB1630CT - SBLB1640CT	G	Power Pack SMD ⁽²⁾	TO-263AB (D ² PAK)	30 - 40	0.55	8.0
SBLF1630CT - SBLF1640CT	G	Isolated Power Pack ⁽²⁾	ITO-220AB	30 - 40	0.55	8.0	
20	MBR2035CT - MBR2060CT	G	Plastic Power Pack ⁽²⁾	TO-220AB	35 - 60	0.84 / 0.80 ⁽⁴⁾	20 / 10
	MBRB2035CT - MBRB2060CT	G	Power Pack SMD ⁽²⁾	TO-263AB (D ² PAK)	35 - 60	0.84 / 0.80 ⁽⁴⁾	20 / 10
	MBRF2035CT - MBRF2060CT	G	Isolated Power Pack ⁽²⁾	ITO-220AB	35 - 60	0.84 / 0.80 ⁽⁴⁾	20 / 10
	MBR20H35CT - MBR20H60CT	G	Plastic Power Pack ⁽²⁾	TO-220AB	35 - 60	0.63 / 0.71 ⁽⁴⁾	10
	MBRB20H35CT - MBRB20H60CT	G	Power Pack SMD ⁽²⁾	TO-263AB (D ² PAK)	35 - 60	0.63 / 0.71 ⁽⁴⁾	10
	MBRF20H35CT - MBRF20H60CT	G	Isolated Power Pack ⁽²⁾	ITO-220AB	35 - 60	0.63 / 0.71 ⁽⁴⁾	10
	MBR2090CT - MBR20100CT	G	Plastic Power Pack ⁽²⁾	TO-220AB	90 - 100	0.80	10
	MBRB2090CT - MBRB20100CT	G	Power Pack SMD ⁽²⁾	TO-263AB (D ² PAK)	90 - 100	0.80	10
	MBRF2090CT - MBRF20100CT	G	Isolated Power Pack ⁽²⁾	ITO-220AB	90 - 100	0.80	10
	MBR20H90CT - MBR20H100CT	G	Plastic Power Pack ⁽²⁾	TO-220AB	90 - 100	0.77	10
	MBRB20H90CT - MBRB20H100CT	G	Power Pack SMD ⁽²⁾	TO-263AB (D ² PAK)	90 - 100	0.77	10
	MBRF20H90CT - MBRF20H100CT	G	Isolated Power Pack ⁽²⁾	ITO-220AB	90 - 100	0.77	10
	MBR20H90CTG - MBR20H100CTG	G	Plastic Power Pack ⁽²⁾	TO-220AB	90 - 100	0.85	10
	MBRB20H90CTG - MBRB20H100CTG	G	Power Pack SMD ⁽²⁾	TO-263AB (D ² PAK)	90 - 100	0.85	10
MBRF20H90CTG - MBRF20H100CTG	G	Isolated Power Pack ⁽²⁾	ITO-220AB	90 - 100	0.85	10	

Notes:

(1) **Bold Text** = New Products

(2) Dual center-tapped device (V_F limit @ I_F is per leg)

(3) All Schottky die are planar with oxide passivation

(4) 35 V - 45 V product / 50 V - 60 V product

(5) Source: G = Formerly General Semiconductor[®]

T = Formerly Vishay Telefunken[®] (Telefunken[®] is a registered trademark of Electro Holding GMBH)

→ = Transferred

Rectifiers Selector Guide



Schottky Rectifiers

I _{F(AV)} (A)	Device ⁽¹⁾	Source ⁽⁵⁾	Package		V _(BR) Range (V)	Max V _F @ I _F	
			Family ⁽³⁾	Type		(V)	(A)
20 (cont'd)	MBR20H150CT	G	Plastic Power Pack ⁽²⁾	TO-220AB	150	0.90	10
	SB20H150CT-1	G	Plastic Power Pack ⁽²⁾	TO-262AA	150	0.90	10
	MBRF20H150CT	G	Isolated Power Pack ⁽²⁾	ITO-220AB	150	0.90	10
	MBR20H200CT	G	Plastic Power Pack ⁽²⁾	TO-220AB	200	0.88	10
	SB20H200CT-1	G	Power Pack SMD ⁽²⁾	TO-262AA	200	0.88	10
	MBRF20H200CT	G	Isolated Power Pack ⁽²⁾	ITO-220AB	200	0.88	10
	M2035S & M2045S	G	Plastic Power Pack	TO-220AB	35 - 45	0.7	20
	MI2056C - MI2060C	G	Plastic Power Pack ⁽²⁾	TO-262AA	50 - 60	0.74	10
	SBL2030CT - SBL2040CT	G	Plastic Power Pack ⁽²⁾	TO-220AB	30 - 40	0.55	10
	SBLB2030CT - SBLB2040CT	G	Power Pack SMD ⁽²⁾	TO-263AB (D ² PAK)	30 - 40	0.55	10
SBLF2030CT - SBLF2040CT	G	Isolated Power Pack ⁽²⁾	ITO-220AB	30 - 40	0.55	10	
SBL2030PT - SBL2040PT	G	Plastic Power Pack ⁽²⁾	TO-247AD (TO-3P)	30 - 40	0.55	10	
25	SBL25L20CT - SBL25L30CT	G	Plastic Power Pack ⁽²⁾	TO-220AB	20 - 30	0.49	12.5
	SBLB25L20CT - SBLB25L30CT	G	Power Pack SMD ⁽²⁾	TO-263AB (D ² PAK)	20 - 30	0.49	12.5
	SBLF25L20CT - SBLF25L30CT	G	Isolated Power Pack ⁽²⁾	ITO-220AB	20 - 30	0.49	12.5
30	MBR2535CT - MBR2560CT	G	Plastic Power Pack ⁽²⁾	TO-220AB	35 - 60	0.82 / 0.75 ⁽⁴⁾	30 / 15
	MBRB2535CT - MBRB2560CT	G	Power Pack SMD ⁽²⁾	TO-263AB (D ² PAK)	35 - 60	0.82 / 0.75 ⁽⁴⁾	30 / 15
	MBRF2535CT - MBRF2560CT	G	Isolated Power Pack ⁽²⁾	ITO-220AB	35 - 60	0.82 / 0.75 ⁽⁴⁾	30 / 15
	MBR25H35CT - MBR25H60CT	G	Plastic Power Pack ⁽²⁾	TO-220AB	35 - 60	0.64 / 0.70 ⁽⁴⁾	15
	MBRB25H35CT - MBRB25H60CT	G	Power Pack SMD ⁽²⁾	TO-263AB (D ² PAK)	35 - 60	0.64 / 0.70 ⁽⁴⁾	15
	MBRF25H35CT - MBRF25H60CT	G	Isolated Power Pack ⁽²⁾	ITO-220AB	35 - 60	0.64 / 0.70 ⁽⁴⁾	15
	MBR3035CT - MBR3045CT	G	Plastic Power Pack ⁽²⁾	TO-220AB	35 - 45	0.76	30
	MBRB3035CT - MBRB3045CT	G	Power Pack SMD ⁽²⁾	TO-263AB (D ² PAK)	35 - 45	0.76	30
	MBRF3035CT - MBRF3045CT	G	Isolated Power Pack ⁽²⁾	ITO-220AB	35 - 45	0.76	30
	MBR30H35CT - MBR30H60CT	G	Plastic Power Pack ⁽²⁾	TO-220AB	35 - 60	0.62 / 0.68 ⁽⁴⁾	15
	MBRB30H35CT - MBRB30H60CT	G	Power Pack SMD ⁽²⁾	TO-263AB (D ² PAK)	35 - 60	0.62 / 0.68 ⁽⁴⁾	15
	MBRF30H35CT - MBRF30H60CT	G	Isolated Power Pack ⁽²⁾	ITO-220AB	35 - 60	0.62 / 0.68 ⁽⁴⁾	15
	MBR3035PT - MBR3060PT	G	Plastic Power Pack ⁽²⁾	TO-247AD (TO-3P)	35 - 60	0.76 / 0.75 ⁽⁴⁾	30 / 20
	MBR30H35PT - MBR30H60PT	G	Plastic Power Pack ⁽²⁾	TO-247AD (TO-3P)	35 - 60	0.66 / 0.74 ⁽⁴⁾	20
	MBR30H90PT - MBR30H100PT	G	Plastic Power Pack ⁽²⁾	TO-247AD (TO-3P)	90 - 100	0.84	15
	MBR30H150CT	G	Plastic Power Pack ⁽²⁾	TO-220AB	150	0.90	15
	SB30H150CT-1	G	Plastic Power Pack ⁽²⁾	TO-262AA	150	0.90	15
	MBRF30H150CT	G	Isolated Power Pack ⁽²⁾	ITO-220AB	150	0.90	15
	M3035S - M3045S	G	Plastic Power Pack	TO-220AB	35 - 45	0.7	30
	M1300356 - M13045S	G	Plastic Power Pack	TO-262AA	35 - 45	0.7	30
	MI3035S & MI3045S	G	Plastic Power Pack	TO-262AA	35 - 45	0.7	30
	M3060C	G	Plastic Power Pack ⁽²⁾	TO-220AB	60	0.72	15
	MI3060C	G	Plastic Power Pack ⁽²⁾	TO-262AA	60	0.72	15
MF3060C	G	Isolated Power Pack ⁽²⁾	ITO-220AB	60	0.72	15	
M30L40C	G	Plastic Power Pack ⁽²⁾	TO-220AB	40	0.55	15	
SBL3030PT - SBL3040PT	G	Plastic Power Pack ⁽²⁾	TO-247AD (TO-3P)	30 - 40	0.55	15	
SD241P	G	Plastic Power Pack ⁽²⁾	TO-247AD (TO-3P)	45	0.47 / 0.60	10 / 20 (125 °C)	
40	MBR4035PT - MBR4060PT	G	Plastic Power Pack ⁽²⁾	TO-247AD (TO-3P)	35 - 60	0.70 / 0.72 ⁽⁴⁾	20
	MBR40H35PT - MBR40H60PT	G	Plastic Power Pack ⁽²⁾	TO-247AD (TO-3P)	35 - 60	0.63 / 0.69 ⁽⁴⁾	20
	SBL4030PT - SBL4040PT	G	Plastic Power Pack ⁽²⁾	TO-247AD (TO-3P)	30 - 40	0.58	20
60	MBR60100CT	G	Plastic Power Pack ⁽²⁾	TO-220AB	100	0.82 / 1.0 ⁽⁴⁾	30 / 60
	M6035C - M6060C	G	Plastic Power Pack ⁽²⁾	TO-220AB	35 - 60	0.61 / 0.65 ⁽⁴⁾	30
	M6035P - M6060P	G	Plastic Power Pack ⁽²⁾	TO-247AD (TO-3P)	35 - 60	0.60 / 0.64 ⁽⁴⁾	30

Notes:

(1) **Bold Text** = New Products

(2) Dual center-tapped device (V_F limit @ I_F is per leg)

(3) All Schottky die are planar with oxide passivation

(4) 35 V - 45 V product / 50 V - 60 V product

(5) Source: G = Formerly General Semiconductor®

T = Formerly Vishay Telefunken® (Telefunken® is a registered trademark of Electro Holding GmbH)

-> = Transferred



Ultrafast Recovery Rectifiers have very fast reverse recovery times (as low as 15 ns) and voltage levels as high as 1500 V. They are ideally suited for very high frequency switching power supplies, inverters, and freewheeling diodes. Both platinum-doped types with excellent high-temperature leakage current and gold-doped types for soft reverse recovery with excellent recovery temperature stability are offered.

I _{F(AV)} (A)	Device ⁽¹⁾	Source ⁽⁴⁾	Package		V _(BR) Range (V)	Max V _F @ I _F		t _{rr} (ns)
			Family	Type		(V)	(A)	
0.5	BYM07-xxx	G	SUPERECTIFIER® SMD	DO-213AA (MiniMELF)	50 - 400	1.25 / 1.35	0.5	50
	EGL34y	G	SUPERECTIFIER® SMD	DO-213AA (MiniMELF)	50 - 400	1.25 / 1.35	0.5	50
0.6	UG06y	G	Plastic Axial ⁽²⁾	MPG06	50 - 200	0.95	0.6	15
1.0	BYM12-xxx	G	SUPERECTIFIER® SMD	DO-213AB (MELF)	50 - 400	1.0 / 1.25	1.0	50
	BYV26A-E	T	Sinterglass Axial	SOD57	200 - 1000	2.5	1.0	30 / 75
	BYV26DGP & EGP	G	SUPERECTIFIER® Axial	DO-204AC (DO-15)	800 - 1000	2.5	1.0	75
	EGF1y	G	SUPERECTIFIER® SMD	DO-214BA (GF1)	50 - 200	1.0	1.0	50
	EGF1T	G	SUPERECTIFIER® SMD	DO-214BA (GF1)	1300	3.0	1.0	75
	EGL41y	G	SUPERECTIFIER® SMD	DO-213AB (MELF)	50 - 400	1.0 / 1.25	1.0	50
	EGP10x	G	SUPERECTIFIER® Axial	DO-204AL (DO-41)	50 - 400	0.95 / 1.25	1.0	50
	ES1y	G	Plastic SMD ⁽²⁾	DO-214AC (SMA)	50 - 200	0.92	1.0	15
	ES1Py	G	Plastic SMD ⁽²⁾	DO-220AA (SMP)	50 - 200	0.865 / 0.92	0.6 / 1.0	15
	ESH1y	G	Plastic SMD ⁽²⁾	DO-214AC (SMA)	100 - 200	0.87 / 0.90	0.7 / 1.0	25
	FGP10B-FGP10D	G	SUPERECTIFIER® Axial	DO-204AL (DO-41)	100 - 200	0.95	1.0	35
	ESH1Py	G	Plastic SMD ⁽²⁾	DO-220AA (SMP)	100 - 200	0.86 / 0.90	0.7 / 1.0	25
	FE1y	G → T	Sinterglass Axial	DO-204AP	50 - 200	0.95	1.0	35
	GI1001 - GI1004	G → T	Sinterglass Axial	DO-204AP	50 - 200	0.975	1.0	25
	MUR120	G	Plastic Axial ⁽²⁾	DO-204AC (DO-15)	200	0.875	1.0	25
	MUR140 - MUR160	G	Plastic Axial ⁽²⁾	DO-204AC (DO-15)	400 - 600	1.25	1.0	50
	MURS120	G	Plastic SMD ⁽²⁾	DO-214AA (SMB)	200	0.875	1.0	25
	MURS140 - MURS160	G	Plastic SMD ⁽²⁾	DO-214AA (SMB)	400 - 600	1.25	1.0	50
	SBYV26C	G	SUPERECTIFIER® Axial	DO-204AL (DO-41)	600	2.5	1.0	30
	SF4001 - SF4007	T	Sinterglass Axial	SOD57	50 - 1000	1.0 / 1.7	1.0	50 / 75
	SF1200 / SF1600	T	Sinterglass Axial	SOD57	1200 / 1600	3.4	1.0	75
UF4001 - UF4007	G	Plastic Axial ⁽²⁾	DO-204AL (DO-41)	50 - 1000	1.0 / 1.7	1.1	50 / 75	
UG1y	G	Plastic Axial ⁽²⁾	DO-204AL (DO-41)	50 - 200	0.95	1.0	15	
US1y	G	Plastic SMD ⁽²⁾	DO-214AC (SMA)	50 - 1000	1.0 / 1.7	1.1	50 / 75	
1.5	BYG20y	T → G	Plastic SMD ⁽²⁾	DO-214AC (SMA)	200 - 600	1.3	1.0	75
	BYG23M	T → G	Plastic SMD ⁽²⁾	DO-214AC (SMA)	1000	1.7	1.0	75
	SUF15y	G	Plastic Axial ⁽²⁾	GP20	400 & 600	1.8	1.5	35
1.9	BYT53y	T	Sinterglass Axial	SOD57	50 - 400	1.1	1.0	50

Notes:

(1) **Bold Text** = New Products

"x" designates a number that indicates voltage or is part of a sequence

"y" designates reverse voltage, where:

A=50 V C=150 V F=300 V H=500 V

B=100 V D=200 V G=400 V J=600 V

(2) Glass passivated die

(3) Dual center-tapped device (V_F limit @ I_F is per leg)

(4) Source: G = Formerly General Semiconductor®

 T = Formerly Vishay Telefunken® (Telefunken® is a registered trademark of Electro Holding GMBH)

 → = Transferred

Rectifiers Selector Guide



Ultrafast Recovery Rectifiers

I _{F(AV)} (A)	Device ⁽¹⁾	Source ⁽⁴⁾	Package		V _(BR) Range (V)	Max V _F @ I _F		t _{rr} (ns)
			Family	Type		(V)	(A)	
2.0	BYG22y	T → G	Plastic SMD ⁽²⁾	DO-214AC (SMA)	50 - 200	1.1	2	25
	BYV27/50 - 600	T	Sinterglass Axial	SOD57	50 - 600	1.07 / 135	3	25 / 40
	EGP20y	G	SUPERCTIFIER [®] Axial	DO-204AC (DO-15)	50 - 400	0.95 / 1.25	2	50
	ES2A - ES2D	G	Plastic SMD ⁽²⁾	DO-214AA (SMB)	50 - 200	0.9	2	20
	ES2F - ES2G	G	Plastic SMD ⁽²⁾	DO-214AA (SMB)	300 - 400	1.1	2	35
	ESH2B - ESH2D	G	Plastic SMD ⁽²⁾	DO-214AA (SMB)	100 - 200	0.93	2	25
	ESH2PB - ESH2PD	G	Plastic SMD ⁽²⁾	DO-220AA (SMP)	100 - 200	0.98	2	25
	MURS240 - MURS260	G	Plastic SMD ⁽²⁾	DO-214AA (SMB)	400-600	1.45	2	50
	USB260	G	Plastic SMD ⁽²⁾	DO-214AA (SMB)	600	1.60	2	30
	FE2y	G → T	Sinterglass Axial	DO-204AP	50 - 200	0.95	2	35
	FGP20B - FGP20D	G	SUPERCTIFIER [®] Axial	DO-204AC (DO-15)	100 - 200	0.95	2	35
	SBYV27-xxx	G	Plastic Axial ⁽²⁾	DO-204AC (DO-15)	50 - 200	1.07	3	15
	UG2y	G	Plastic Axial ⁽²⁾	DO-204AC (DO-15)	50 - 200	0.95	2	15
	UG2F & UG2G	G	Plastic Axial ⁽²⁾	DO-204AC (DO-15)	300-400	1.10	2	35
3.0	31GF4	G	Plastic Axial ⁽²⁾	DO-201AD	400	1.25	3	30
	31GF6	G	Plastic Axial ⁽²⁾	DO-201AD	600	1.6	3	30
	BYW178	T	Sinterglass Axial	SOD64	800	1.9	3	60
	EGP30y	G	SUPERCTIFIER [®] Axial	GP20	50 - 400	0.95 / 1.25	3	50
	ES3y	G	Plastic SMD ⁽²⁾	DO-214AB (SMC)	50 - 200	0.9	3	20
	ES3F - ES3G	G	Plastic SMD ⁽²⁾	DO-214AB (SMC)	300 - 400	1.1	3	35
	ESH3A - ESH3D	G	Plastic SMD ⁽²⁾	DO-214AA (SMB)	100 - 200	0.90	3	25
	FE3y	G → T	Sinterglass Axial	G4	50 - 200	0.95	3	35
	FGP30B - FGP30D	G	SUPERCTIFIER [®] Axial	DO-204AC (DO-15)	100 - 200	0.95	3	35
	MURS320	G	Plastic SMD ⁽²⁾	DO-214AB (SMC)	200	0.875		25
	MURS340 - MURS360	G	Plastic SMD ⁽²⁾	DO-214AB (SMC)	400 & 600	1.25 / 1.28	3 / 4	50
	SF5400 - SF5407	T	Sinterglass Axial	SOD64	50 - 1000	1.1 / 1.7	3	50 / 75
	SUF30y	G	Plastic Axial ⁽²⁾	P600	400 & 600	1.8 / 2.0	3	35
	UF5400 - UF5408	G	Plastic Axial ⁽²⁾	DO-201AD	50 - 1000	1.0 / 1.7	3	50 / 75
3.5	BYV28/50-600	T	Sinterglass Axial	SOD64	50 - 600	1.1 / 1.35	5	30 / 50
	SBYV28-xxx	G	Plastic Axial ⁽²⁾	DO-201AD	50 - 200	1.1	3.5	20
4.0	MUR420	G	Plastic Axial ⁽²⁾	DO-201AD	200	0.89	4	25
	MUR440 - MUR460	G	Plastic Axial ⁽²⁾	DO-201AD	400 - 600	1.28	4	50
	UG4y	G	Plastic Axial ⁽²⁾	DO-201AD	50 - 200	0.95	4	20
5.0	EGP50y	G	SUPERCTIFIER [®] Axial	GP20	50 - 400	0.95 / 1.25	5	50
	FGP50B - FGP50D	G	SUPERCTIFIER [®] Axial	GP20	100 - 200	0.95	5	35
	FE5y	G → T	Sinterglass Axial	G4	50 - 200	0.95	5	35
	GUR5H60	G	Plastic Power Pack ⁽²⁾	TO-220AC	600	1.8	5	30
	GURB5H60	G	Power Pack SMD ⁽²⁾	TO-263AB(D ² PAK)	600	1.8	5	30
	GURF5H60	G	Isolated Power Pack ⁽²⁾	ITO-220AC	600	1.8	5	30
	UG5HT - UG5JT	G	Plastic Power Pack ⁽²⁾	TO-220AC	500 - 600	1.75	5	25
	UGB5HT - UGB5JT	G	Power Pack SMD ⁽²⁾	TO-263AB(D ² PAK)	500 - 600	1.75	5	25
	UGF5HT - UGF5JT	G	Isolated Power Pack ⁽²⁾	ITO-220AC	500 - 600	1.75	5	25
UH5JT	G	Plastic Power-pack ⁽²⁾	TO-220AC	600	3	5	25	

Notes:

(1) **Bold Text** = New Products

"x" designates a number that indicates voltage or is part of a sequence

"y" designates reverse voltage, where:

A=50 V C=150 V F=300 V H=500 V

B=100 V D=200 V G=400 V J=600 V

(2) Glass passivated die

(3) Dual center-tapped device (V_F limit @ I_F is per leg)

(4) Source: G = Formerly General Semiconductor[®]

T = Formerly Vishay Telefunken[®] (Telefunken[®] is a registered trademark of Electro Holding GmbH)

→ = Transferred



I _{F(AV)} (A)	Device ⁽¹⁾	Source ⁽⁴⁾	Package		V _(BR) Range (V)	Max V _F @ I _F		t _{rr} (ns)
			Family	Type		(V)	(A)	
6.0	FE6y	G → T	Sinterglass Axial	G4	50 - 200	0.975	6.0	35
	FEP6yT	G	Plastic Power Pack ⁽²⁾⁽³⁾	TO-220AB	50 - 200	0.975	3.0	35
	FEPB6yT	G	Power Pack SMD ⁽²⁾⁽³⁾	TO-263AB (D ² PAK)	50 - 200	0.975	3.0	35
	FEPF6yT	G	Isolated Power Pack ⁽²⁾⁽³⁾	ITO-220AB	50 - 200	0.975	3.0	35
8.0	BYV29-xxx	G	Plastic Power Pack ⁽²⁾	TO-220AC	300 - 400	1.3	8.0	35
	BYV29B-xxx	G	Power Pack SMD ⁽²⁾	TO-263AB (D ² PAK)	300 - 400	1.3	8.0	35
	BYV29F-xxx	G	Isolated Power Pack ⁽²⁾	ITO-220AC	300 - 400	1.3	8.0	35
	BYW29-xx	G	Plastic Power Pack ⁽²⁾	TO-220AC	50 - 200	1.3	8.0	25
	BYWB29-xx	G	Power Pack SMD ⁽²⁾	TO-263AB(D ² PAK)	50 - 200	1.3	8.0	25
	BYWF29-xx	G	Isolated Power Pack ⁽²⁾	ITO-220AC	50 - 200	1.3	8.0	25
	FES8yT	G	Plastic Power Pack ⁽²⁾	TO-220AC	50 - 600	0.95 / 1.3 / 1.5	8.0	35 / 50
	FESB8yT	G	Power Pack SMD ⁽²⁾	TO-263AB (D ² PAK)	50 - 600	0.95 / 1.3 / 1.5	8.0	35 / 50
	FESF8yT	G	Isolated Power Pack ⁽²⁾	ITO-220AC	50 - 600	0.95 / 1.3 / 1.5	8.0	35 / 50
	G11401 - G11404	G	Plastic Power Pack ⁽²⁾	TO-220AC	50 - 200	0.975	8.0	35
	G1B1401 - G1B1404	G	Power Pack SMD ⁽²⁾	TO-263AB (D ² PAK)	50 - 200	0.975	8.0	35
	UG8AT - UG8DT	G	Plastic Power Pack ⁽²⁾	TO-220AC	50 - 200	1.0	8.0	20
	UGB8AT - UGB8DT	G	Power Pack SMD ⁽²⁾	TO-263AB (D ² PAK)	50 - 200	1.0	8.0	20
	UGF8AT - UGF8DT	G	Isolated Power Pack ⁽²⁾	ITO-220AC	50 - 200	1.0	8.0	20
	UG8FT - UG8GT	G	Plastic Power Pack ⁽²⁾	TO-220AC	300 - 400	1.3	8.0	35
	UGB8FT - UGB8GT	G	Power Pack SMD ⁽²⁾	TO-263AB (D ² PAK)	300 - 400	1.3	8.0	35
	UGF8FT - UGF8GT	G	Isolated Power Pack ⁽²⁾	ITO-220AC	300 - 400	1.3	8.0	35
	UG8HT - UG8JT	G	Plastic Power Pack ⁽²⁾	TO-220AC	500 - 600	1.75	8.0	25
	UGB8HT - UGB8JT	G	Power Pack SMD ⁽²⁾	TO-263AB (D ² PAK)	500 - 600	1.75	8.0	25
	UGF8HT - UGF8JT	G	Isolated Power Pack ⁽²⁾	ITO-220AC	500 - 600	1.75	8.0	25
UG8HCT - UG8JCT	G	Plastic Power Pack ⁽²⁾⁽³⁾	TO-220AB	500 - 600	1.75	4.0	25	
UGB8HCT - UGB8JCT	G	Power Pack SMD ⁽²⁾⁽³⁾	TO-263AB (D ² PAK)	500 - 600	1.75	4.0	25	
UGF8HCT - UGF8JCT	G	Isolated Power Pack ⁽²⁾⁽³⁾	ITO-220AB	500 - 600	1.75	4.0	25	
UH8JT	G	Plastic Power Pack	TO-220AC	600	3.0	8	25	
UHF8JT	G	Isolated Power Pack	ITO-220AC	600	3.0	8	25	
10	BYQ28E-xxx	G	Power Pack SMD ⁽²⁾⁽³⁾	TO-220AB	100 - 200	1.1	5.0	25
	BYQ28EB-xxx	G	Power Pack SMD ⁽²⁾⁽³⁾	TO-263AB (D ² PAK)	100 - 200	1.1	5.0	25
	BYQ28EF-xxx	G	Isolated Power Pack ⁽²⁾⁽³⁾	ITO-220AB	100 - 200	1.1	5.0	25
	BYT28-xxx	G	Plastic Power Pack ⁽²⁾⁽³⁾	TO-220AB	300 - 400	1.3	5.0	35
	BYT28B-xxx	G	Power Pack SMD ⁽²⁾⁽³⁾	TO-263AB (D ² PAK)	300 - 400	1.3	5.0	35
	BYT28F-xxx	G	Isolated Power Pack ⁽²⁾⁽³⁾	ITO-220AB	300 - 400	1.3	5.0	35
	UG10BCT - UG10DCT	G	Plastic Power Pack ⁽²⁾⁽³⁾	TO-220AB	100 - 200	1.1	5.0	25
	UGB10BCT - UGB10DCT	G	Power Pack SMD ⁽²⁾⁽³⁾	TO-263AB (D ² PAK)	100 - 200	1.1	5.0	25
	UGF10BCT - UGF10DCT	G	Isolated Power Pack ⁽²⁾⁽³⁾	ITO-220AB	100 - 200	1.1	5.0	25
	UG10FCT - UG10GCT	G	Plastic Power Pack ⁽²⁾⁽³⁾	TO-220AB	300 - 400	1.3	5.0	35
	UGB10FCT - UGB10GCT	G	Power Pack SMD ⁽²⁾⁽³⁾	TO-263AB (D ² PAK)	300 - 400	1.3	5.0	35
	UGF10FCT - UGF10GCT	G	Isolated Power Pack ⁽²⁾⁽³⁾	ITO-220AB	300 - 400	1.3	5.0	35
	UH10JT	G	Plastic Power Pack	TO-220AC	600	3	10	25
	UHF10JT	G	Isolated Power Pack	ITO-220AC	600	3	10	25
UH10FT	G	Plastic Power Pack	TO-220AC	300	1.2	10	25	

Notes:

(1) **Bold Text** = New Products

"x" designates a number that indicates voltage or is part of a sequence

"y" designates reverse voltage, where:

A=50 V C=150 V F=300 V H=500 V

B=100 V D=200 V G=400 V J=600 V

(2) Glass passivated die

(3) Dual center-tapped device (V_F limit @ I_F is per leg)

(4) Source: G = Formerly General Semiconductor[®]

T = Formerly Vishay Telefunken[®] (Telefunken[®] is a registered trademark of Electro Holding GMBH)

→ = Transferred

Rectifiers Selector Guide



Ultrafast Recovery Rectifiers

I _{F(AV)} (A)	Device ⁽¹⁾	Source ⁽⁴⁾	Package		V _(BR) Range (V)	Max V _F @ I _F		t _{rr} (ns)
			Family	Type		(V)	(A)	
10 (cont'd)	UHB10FT	G	Power Pack SMD	TO-263AB (D ² PAK)	300	1.2	10	25
	U10DCT	G	Plastic Power Pack ⁽³⁾	TO-220AB	100-200	1.1	10	20
	UB10DCT	G	Power Pack SMD ⁽³⁾	TO-263AB (D ² PAK)	100-200	1.1	10	20
12	UG12HT - UG12JT	G	Plastic Power Pack ⁽²⁾	TO-220AC	500 - 600	1.75	12	30
	UGB12HT - UGB12JT	G	Power Pack SMD ⁽²⁾	TO-263AB (D ² PAK)	500 - 600	1.75	12	30
	UGF12HT - UGF12JT	G	Isolated Power Pack ⁽²⁾	ITO-220AC	500 - 600	1.75	12	30
15	UG15JT	G	Plastic Power Pack ⁽²⁾	TO-220AB	500 - 600	1.75	15	35
	UGB15JT	G	Power Pack SMD ⁽²⁾	TO-263AB (D ² PAK)	500 - 600	1.75	15	35
	UGF15JT	G	Isolated Power Pack ⁽²⁾	ITO-220AB	500 - 600	1.75	15	35
16	FEP16yT	G	Plastic Power Pack ⁽²⁾⁽³⁾	TO-220AB	50 - 600	0.95 / 1.3 / 1.5	8.0	35 / 50
	FEPB16yT	G	Power Pack SMD ⁽²⁾⁽³⁾	TO-263AB	50 - 600	0.95 / 1.3 / 1.5	8.0	35 / 50
	FEPF16yT	G	Isolated Power Pack ⁽²⁾⁽³⁾	ITO-220AB	50 - 600	0.95 / 1.3 / 1.5	8.0	35 / 50
	FES16yT	G	Plastic Power Pack ⁽²⁾	TO-220AC	50 - 600	0.975 / 1.3 / 1.5	16	35 / 50
	FESB16yT	G	Power Pack SMD ⁽²⁾	TO-263AB (D ² PAK)	50 - 600	0.975 / 1.3 / 1.5	16	35 / 50
	FESF16yT	G	Isolated Power Pack ⁽²⁾	ITO-220AC	50 - 600	0.975 / 1.3 / 1.5	16	35 / 50
	GI2401 - GI2404	G	Plastic Power Pack ⁽²⁾⁽³⁾	TO-220AB	50 - 200	0.975	16	35
	GIB2401 - GIB2404	G	Power Pack SMD ⁽²⁾⁽³⁾	TO-263AB	50 - 200	0.975	16	35
	U160BCT - U16DCT	G	Plastic Power Pack ⁽²⁾⁽³⁾	TO-220AB	100 - 200	1.10	8	35
	UB160BCT - UB16DCT	G	Power-pack SMD ⁽²⁾⁽³⁾	TO-263AB(D ² PAK)	100 - 200	1.00	8	35
18	BYV32-xx	G	Plastic Power Pack ⁽²⁾⁽³⁾	TO-220AB	50 - 200	1.15	20	25
	BYVB32-xx	G	Power Pack SMD ⁽²⁾⁽³⁾	TO-263AB(D ² PAK)	50 - 200	1.15	20	25
	BYVF32-xx	G	Isolated Power Pack ⁽²⁾⁽³⁾	ITO-220AB	50 - 200	1.15	20	25
	UG18yCT	G	Plastic Power Pack ⁽²⁾⁽³⁾	TO-220AB	50 - 200	1.1	9.0	20
	UGB18yCT	G	Power Pack SMD ⁽²⁾⁽³⁾	TO-263AB(D ² PAK)	50 - 200	1.1	9.0	20
	UGF18yCT	G	Isolated Power Pack ⁽²⁾⁽³⁾	ITO-220AB	50 - 200	1.1	9.0	20
20	U20BCT - U20DCT	G	Plastic Power Pack ⁽²⁾⁽³⁾	TO-220AB	100 - 200	1.00	10	35
	UB20BCT - UB20DCT	G	Power Pack SMD ⁽²⁾⁽³⁾	TO-263AB(D ² PAK)	100 - 200	1.00	10	35
	UH20FCT	G	Plastic Power Pack ⁽³⁾	TO-220AB	300	1.2	10	25
	UHB20FCT	G	Power-Pack SMD ⁽³⁾	TO-263AB(D ² PAK)	300	1.2	10	25
30	FEP30yP	G	Plastic Power Pack ⁽²⁾⁽³⁾	TO-247AD	50 - 600	0.95 / 1.3 / 1.5	15	35 / 50
	U30BCT - U30DCT	G	Plastic Power Pack ⁽²⁾⁽³⁾	TO-220AB	100 - 200	1.05	15	25
	UB30BCT - UB30DCT	G	Power Pack SMD ⁽²⁾⁽³⁾	TO-263AB(D ² PAK)	100 - 200	1.05	15	25
	UG30yPT	G	Plastic Power Pack ⁽²⁾⁽³⁾	TO-247AD	50 - 200	1.0	15	20

Notes:

(1) **Bold Text** = New Products

"x" designates a number that indicates voltage or is part of a sequence

"y" designates reverse voltage, where:

A=50 V C=150 V F=300 V H=500 V

B=100 V D=200 V G=400 V J=600 V

(2) Glass passivated die

(3) Dual center-tapped device (V_r limit @ I_r is per leg)

(4) Source: G = Formerly General Semiconductor®

 T = Formerly Vishay Telefunken® (Telefunken® is a registered trademark of Electro Holding GmbH)

 → = Transferred



Fast Recovery Rectifiers are used for applications requiring reverse recovery times in the range of 100 ns to 750 ns. Typical uses are low-frequency SMPS, motor controllers, and electronic ballasts. These products are offered in axial, surface-mount, and power packages.

I _{F(AV)} (A)	Device ⁽¹⁾	Source ⁽³⁾	Package		V _(BR) Range (V)	Max V _F @ I _F		t _{rr} (ns)
			Family	Type		(V)	(A)	
0.25	BY203	T	Sinterglass Axial	SOD57	1200 - 2000	2.4	0.2	300
0.5	GHR16	G	Plastic Axial	R-1 (Photoflash diode)	1600	1.5	0.5	300
	RGL34y	G	SUPERCTIFIER® SMD	DO-213AA (MiniMELF)	50 - 600	1.3	0.5	150 - 250
	RGP02-xxE	G	SUPERCTIFIER® Axial	GP10E	1200 - 2000	1.8	0.1	300
0.8	BY268 / 269	T	Sinterglass Axial	SOD57	1400 / 1600	1.25	0.4	400
1.0	1N4933 - 1N4937	G	Plastic Axial	DO-204AL (DO-41)	50 - 600	1.2	1.0	200
	1N4933GP - 1N4937GP	G	SUPERCTIFIER® Axial	DO-204AL (DO-41)	50 - 600	1.2	1.0	200
	1N4942GP - 1N4948GP	G	SUPERCTIFIER® Axial	DO-204AL (DO-41)	200 - 1000	1.3	1.0	150 - 500
	1N5615GP - 1N5623GP	G	SUPERCTIFIER® Axial	DO-204AC (DO-15)	200 - 1000	1.2	1.0	150 - 500
	BA157 - BA159	G	Plastic Axial	DO-204AL (DO-41)	400 - 1000	1.3	1.0	150 - 500
	BA157GP - BA159GP	G	SUPERCTIFIER® Axial	DO-204AL (DO-41)	400 - 1000	1.3	1.0	150 - 500
	BYD33yGP	G	SUPERCTIFIER® Axial	DO-204AL (DO-41)	200 - 1000	1.3	1.0	150 - 300
	BYM11-xx	G	SUPERCTIFIER® SMD	DO-213AB (MELF)	50 - 1000	1.3	1.0	150 - 500
	GI81x	G	SUPERCTIFIER® Axial	DO-204AC (DO-15)	50 - 1000	1.2	1.0	750
	RG1y	G → T	Sinterglass Axial	DO-204AP	50 - 1000	1.3	1.0	150 - 500
	RGF1y	G	SUPERCTIFIER® SMD	DO-214BA (GF1)	50 - 1000	1.3	1.0	150 - 500
	RGL41y	G	SUPERCTIFIER® SMD	DO-213AB (MELF)	50 - 1000	1.3	1.0	150 - 500
	RGP10y	G	SUPERCTIFIER® Axial	DO-204AL (DO-41)	50 - 1000	1.3	1.0	150 - 500
	RGP10yE	G	SUPERCTIFIER® Axial	DO-204AL (DO-41)	50 - 1000	1.3	1.0	150 - 500
	RMPG06y	G	Plastic Axial ⁽²⁾	MPG06	50 - 600	1.3	1.0	150 - 200
	RS1y	G	Plastic SMD ⁽²⁾	DO-214AC (SMA)	50 - 800	1.3	1.0	150 - 250
	RS1py	G	Plastic SMD ⁽²⁾	DO-220AA(SMP)	100-600	1.3	1	150 - 250
SRP100y	G	Plastic Axial	DO-204AL (DO-41)	50 - 800	1.3	1.0	100 - 200	
1.25	BYT54	T	Sinterglass Axial	SOD57	50 - 1000	1.5	1.0	100
1.4	BYT52	T	Sinterglass Axial	SOD57	50 - 1000	1.3	1.0	200
1.5	BYG21y	T → G	Plastic SMD ⁽²⁾	DO-214AC (SMA)	800 - 1000	1.5	1.0	120
	BYG24y	T → G	Plastic SMD ⁽²⁾	DO-214AC (SMA)	200 - 600	1.25	1.5	140
	BYV12-16	T	Sinterglass Axial	SOD57	100 - 1000	1.5	1.0	300
	RGP15y	G	SUPERCTIFIER® Axial	DO-204AC (DO-15)	50 - 1000	1.3	1.5	150 - 500
	RS2y	G	Plastic SMD ⁽²⁾	DO-214AA (SMB)	50 - 600	1.3	1.5	150 - 500
2.0	BYV37/38	T	Sinterglass Axial	SOD57	800 / 1000	1.1	1.0	300

Notes:

(1) **Bold Text** = New Products

"x" designates a number that indicates voltage or is part of a sequence

"y" designates reverse voltage, where:

A=50 V C=150 V F=300 V H=500 V K=800 V
 B=100 V D=200 V G=400 V J=600 V M=1000 V

(2) Glass passivated die

(3) Source: G = Formerly General Semiconductor®
 T = Formerly Vishay Telefunken® (Telefunken® is a registered trademark of Electro Holding GMBH)
 → = Transferred

Rectifiers Selector Guide



Fast Recovery Rectifiers

I _{F(AV)} (A)	Device ⁽¹⁾	Source ⁽³⁾	Package		V _(BR) Range (V)	Max V _F @ I _F		t _{rr} (ns)
			Family	Type		(V)	(A)	
2.0 (cont'd)	BYW32-36	T	Sinterglass Axial	SOD57	200 - 600	1.1	1.0	200
	RG2y	G → T	Sinterglass Axial	DO-204AP	50 - 1000	1.3	2.0	150 - 500
	RGP20y	G	SUPERRECTIFIER® Axial	GP20	50 - 600	1.3	2.0	150 - 500
2.5	RGP25y	G	SUPERRECTIFIER® Axial	DO-201AD	50 - 1000	1.3	2.5	150 - 500
2.9	BYM36D & E	T	Sinterglass Axial	SOD64	800 - 1000	1.78	3.0	150
3.0	BY39xP	G	Plastic Axial	DO-201AD	100 - 800	1.25	3.0	500
	BYM36A-C	T	Sinterglass Axial	SOD64	200 - 600	1.6	3.0	100
	BYT56	T	Sinterglass Axial	SOD64	50 - 1000	1.4	3.0	100
	BYT77-78	T	Sinterglass Axial	SOD64	800 / 1000	1.1	3.0	300
	BYW72 - BYW76	T	Sinterglass Axial	SOD64	200 - 600	1.1	3.0	200
	GI850 - GI856	G	Plastic Axial	DO-201AD	50 - 600	1.25	3.0	200
	GI910 - GI917	G	Plastic Axial	DO-201AD	50 - 800	1.25	3.0	750
	RG3y	G → T	Sinterglass Axial	G3	50 - 1000	1.3	3.0	150 - 500
	RG4y	G → T	Sinterglass Axial	G4	50 - 600	1.3	3.0	150 - 500
	RGP30y	G	SUPERRECTIFIER® Axial	DO-201AD	50 - 1000	1.3	3.0	150 - 500
	RS3y	G	Plastic SMD ⁽²⁾	DO-214AB (SMC)	50 - 800	1.3	3.0	150 - 500
5.0	SRP300y	G	Plastic Axial	DO-201AD	50 - 800	1.3	3.0	100 - 200
	BY500-xxx	G	Plastic Axial	DO-201AD	100 - 800	1.35	5.0	200
6.0	GI820 - GI828	G	Plastic Axial	P600	50 - 800	1.1	5.0	200
	SRP600	G	Plastic Axial	P600	50 - 800	1.3	6.0	100 - 200
8.0	BY229-xxx	G	Plastic Power Pack ⁽²⁾	TO-220AC	200 - 800	1.85	20	145
	BY229X-xxx	G	Isolated Power Pack ⁽²⁾	ITO-220AC	200 - 800	1.85	20	145
	BY229B-xxx	G	Power Pack SMD ⁽²⁾	TO-263AB (D ² PAK)	200 - 800	1.85	20	145
10	BYS459 - 1500	G	Plastic Power Pack ⁽²⁾	TO-220AC	1500	1.3	6.5	350
	BYS459B - 1500	G	Power Pack SMD ⁽²⁾	TO-263AB (D ² PAK)	1500	1.3	6.5	350
	BYS459F - 1500	G	Isolated Power Pack ⁽²⁾	ITO-220AC	1500	1.3	6.5	350
	BYS459-1500S	G	Plastic Power Pack ⁽²⁾	TO-220AC	1500	1.35	6.5	220
	BYS459B-1500S	G	Power Pack SMD ⁽²⁾	TO-263AB (D ² PAK)	1500	1.35	6.5	220
	BYS459F-1500S	G	Isolated Power Pack ⁽²⁾	ITO-220AC	1500	1.35	6.5	220
	DTV32	G	Plastic Power Pack ⁽²⁾	TO-220AC	1500	1.5	6.0	175
	DTV32B	G	Power Pack SMD ⁽²⁾	TO-263AB (D ² PAK)	1500	1.5	6.0	175
	DTV32F	G	Isolated Power Pack ⁽²⁾	ITO-220AC	1500	1.5	6.0	175
	DTV56	G	Plastic Power Pack ⁽²⁾	TO-220AC	1500	1.8	6.0	135
	DTV56B	G	Power Pack SMD ⁽²⁾	TO-263AB (D ² PAK)	1500	1.8	6.0	135
DTV56F	G	Isolated Power Pack ⁽²⁾	ITO-220AC	1500	1.8	6.0	135	

Notes:

(1) **Bold Text** = New Products

"x" designates a number that indicates voltage or is part of a sequence

"y" designates reverse voltage, where:

A=50 V C=150 V F=300 V H=500 V K=800 V
 B=100 V D=200 V G=400 V J=600 V M=1000 V

(2) Glass passivated die

(3) Source: G = Formerly General Semiconductor®

T = Formerly Vishay Telefunken® (Telefunken® is a registered trademark of Electro Holding GMBH)

→ = Transferred



Standard Rectifiers are for low-frequency general purpose use in consumer applications. Typical reverse recovery times are approximately 2 μ s. These products are offered with forward current ratings of 0.25 A to 8 A and reverse voltages as high as 4000 V. They are available in plastic, glass, and Superectifier[®] constructions.

I _{F(AV)} (A)	Device ⁽¹⁾	Source ⁽³⁾	Package		V _(BR) Range (V)	Max V _F @ I _F	
			Family	Type		(V)	(A)
0.25	GI250-x	G	SUPERECTIFIER [®] Axial	DO-204AL (DO-41)	1000 - 4000	3.5	0.25
	GP02-xx	G	SUPERECTIFIER [®] Axial	DO-204AL (DO-41)	2000 - 4000	3.0	0.25
0.35	BYT62	T	Sinterglass Axial	SOD57	2400	3.0	0.2
0.5	GL34y	G	SUPERECTIFIER [®] SMD	DO-213AA (MiniMELF)	50 - 1000	1.2 / 1.3	0.5
0.7	S07B - S07M	G → T	Plastic SMD	DO-219 (SMF)	100 - 1000	1.1	1.0
0.8	GP08y	G	SUPERECTIFIER [®] Axial	DO-204AL	50 - 600	1.3	0.8
1.0	1N361xGP & 1N3957GP	G	SUPERECTIFIER [®] Axial	DO-204AL (DO-41)	200 - 100	1.0	1.0
	1N4001-1N4007	G	Plastic Axial	DO-204AL (DO-41)	50 - 1000	1.1	1.0
	1N4001GP-1N4007GP	G	SUPERECTIFIER [®] Axial	DO-204AL (DO-41)	50 - 1000	1.1	1.0
	1N4245GP-1N4249GP	G	SUPERECTIFIER [®] Axial	DO-204AL (DO-41)	200 - 1000	1.2	1.0
	1N4383GP-1N4385GP	G	SUPERECTIFIER [®] Axial	DO-204AC (DO-15)	200 - 600	1.0	1.0
	1N4585GP & 1N4586GP	G	SUPERECTIFIER [®] Axial	DO-204AC (DO-15)	800 - 1000	1.0	1.0
	1N5059-1N5062	G → T	Sinterglass Axial	DO-204AP	200 - 800	1.2	1.0
	1N5059GP-1N5062GP	G	SUPERECTIFIER [®] Axial	DO-204AC (DO-15)	200 - 800	1.2	1.0
	1N5614GP-1N5622GP	G	SUPERECTIFIER [®] Axial	DO-204AC (DO-15)	200 - 1000	1.2	1.0
	1N6478-1N6484	G	SUPERECTIFIER [®] SMD	DO-213AB (MELF)	50 - 1000	1.1	1.0
	BYD13yGP	G	SUPERECTIFIER [®] Axial	DO-204AL (DO-41)	200 - 1000	1.3	1.0
	BYM10-xxx	G	SUPERECTIFIER [®] SMD	DO-213AB (MELF)	50 - 1000	1.1 / 1.2	1.0
	GF1y	G	SUPERECTIFIER [®] SMD	DO-214BA (GF1)	50 - 1000	1.1 / 1.2	1.0
	GI1-xxxGP	G	SUPERECTIFIER [®] Axial	DO-204AC (DO-15)	1200 - 1600	1.1	1.0
	G1y	G → T	Sinterglass Axial	DO-204AP	50 - 1000	1.1 / 1.2	1.0
	GL41y	G	SUPERECTIFIER [®] SMD	DO-213AB (MELF)	50 - 1600	1.1 / 1.2	1.0
	GP10y	G	SUPERECTIFIER [®] Axial	DO-204AL (DO-41)	50 - 1600	1.1 / 1.2 / 1.3	1.0
	GP10yE	G	SUPERECTIFIER [®] Axial	GP10E	50 - 1000	1.3	1.0
	GPP10y	G	Plastic Axial ⁽²⁾	DO-204AL (DO-41)	50 - 1000	1.1	1.0
M100y	G	Plastic Axial	DO-204AL (DO-41)	50 - 1000	1.0 / 1.1	1.0	
MPG06y	G	Plastic Axial ⁽²⁾	MPG06	50 - 1000	1.1	1.0	

Notes:

(1) **Bold Text** = New Products

"x" designates a number that indicates voltage or is part of a sequence

"y" designates reverse voltage, where:

A=50 V C=150 V F=300 V H=500 V K=800 V

B=100 V D=200 V G=400 V J=600 V M=1000 V

(2) Glass passivated die

(3) Source: G = Formerly General Semiconductor[®]

T = Formerly Vishay Telefunken[®] (Telefunken[®] is a registered trademark of Electro Holding GMBH)

→ = Transferred

Rectifiers Selector Guide



Standard Rectifiers

I _{F(AV)} (A)	Device ⁽¹⁾	Source ⁽³⁾	Package		V _(BR) Range (V)	Max V _F @ I _F	
			Family	Type		(V)	(A)
1.0 (cont'd)	S1y	G	Plastic SMD ⁽²⁾	DO-214AC (SMA)	50 - 1000	1.1	1.0
	S1yA	G	Plastic SMD ⁽²⁾	DO-214AC (SMA)	100-1000	1.1	1.0
	S1Py	G	Plastic SMD ⁽²⁾	DO-220AA (SMP)	100 - 1000	1.1	1.0
	S330D	T	Sinterglass Axial	SOD57	1000	1.0	1.0
1.5	1N5391-1N5399	G	Plastic Axial	DO-204AC (DO-15)	50 - 1000	1.4	1.5
	1N5391GP-1N5399GP	G	SUPERCTIFIER [®] Axial	DO-204AC (DO-15)	50 - 1000	1.4	1.5
	AGP15-xxx	G	Plastic Axial ⁽²⁾	DO-204AC (DO-15)	400 - 800	1.1	1.5
	BY448GP	G	SUPERCTIFIER [®] Axial	DO-204AC (DO-15)	1650	1.6	3.0
	BYG10y	T → G	Plastic SMD ⁽²⁾	DO-214AC (SMA)	200 - 1000	1.1	1.0
	BYT51y	T	Sinterglass Axial	SOD57	50 - 1000	1.1	1.0
	CGP15	G	SUPERCTIFIER [®] Axial	DO-204AC (DO-15)	1400	1.1	1.0
	DGP15	G	SUPERCTIFIER [®] Axial	DO-204AC (DO-15)	1500	1.1	1.0
	GP15y	G	SUPERCTIFIER [®] Axial	DO-204AC (DO-15)	50 - 1000	1.1	1.5
	GPP15y	G	Plastic Axial	DO-204AC (DO-15)	50 - 1000	1.1	1.5
	S2y	G	Plastic SMD ⁽²⁾	DO-214AA (SMB)	50 - 1000	1.15	1.5
2.0	SA2y	G	Plastic SMD ⁽²⁾	DO-214AC (SMA)	100 - 1000	1.1	2.0
	BY448 & BY458	T	Sinterglass Axial	SOD57	1500 / 1200	1.6	3.0
	BY527	T	Sinterglass Axial	SOD57	800	1.0	1.0
	BYW52 - BYW56	T	Sinterglass Axial	SOD57	200 - 1000	1.0	1.0
	BYX82 - BYX86	T	Sinterglass Axial	SOD57	200 - 1000	1.0	1.0
	CGP20	G	SUPERCTIFIER [®] Axial	DO-204AC (DO-15)	1400	1.1	2.0
	DGP20	G	SUPERCTIFIER [®] Axial	DO-204AC (DO-15)	1500	1.1	2.0
	G2y	G → T	Sinterglass Axial	DO-204AP	50 - 1000	1.1 / 1.2	2.0
	GP20y	G	SUPERCTIFIER [®] Axial	GP20	50 - 600	1.1 / 1.2	2.0
GPP20y	G	Plastic Axial ⁽²⁾	DO-204AC (DO-15)	50 - 1000	1.1	2.0	
2.5	BY228GP	G	SUPERCTIFIER [®] Axial	DO-201AD	1500	1.6	2.5

Notes:

(1) **Bold Text** = New Products

"x" designates a number that indicates voltage or is part of a sequence

"y" designates reverse voltage, where:

A=50 V C=150 V F=300 V H=500 V K=800 V
 B=100 V D=200 V G=400 V J=600 V M=1000 V

(2) Glass passivated die

(3) Source: G = Formerly General Semiconductor[®]

T = Formerly Vishay Telefunken[®] (Telefunken[®] is a registered trademark of Electro Holding GMBH)

→ = Transferred



I _{F(AV)} (A)	Device ⁽¹⁾	Source ⁽³⁾	Package		V _(BR) Range (V)	Max V _F @ I _F	
			Family	Type		(V)	(A)
3.0	1N5400 - 1N5408	G	Plastic Axial	DO-201AD	50 - 1000	1.2	3.0
	1N5550 - 1N5552	G → T	Sinterglass Axial	G4	200 - 600	1.2	9.0
	1N5624 - 1N5627	G → T	Sinterglass Axial	G3	200 - 800	1.0	3.0
	1N5624GP - 1N5627GP	G	SUPERRECTIFIER® Axial	DO-201AD	200 - 800	1.0	3.0
	BY251GP - BY255GP	G	Plastic Axial ⁽²⁾	DO-201AD	200 - 1300	1.1	3.0
	BY251P - BY255P	G	Plastic Axial ⁽²⁾	DO-201AD	200 - 1300	1.1	3.0
	BY251P	G	Plastic Axial ⁽²⁾	DO-201AD	200 - 1300	1.1	3.0
	BY228	T	Sinterglass Axial	SOD64	1500	1.5	5.0
	BY228/13, BY228/15	T	Sinterglass Axial	SOD64	1000 - 1200	1.5	5.0
	BYW82 - BYW86	T	Sinterglass Axial	SOD64	200 - 1000	1.0	3.0
	CGP30	G	SUPERRECTIFIER® Axial	DO-201AD	1400	1.2	3.0
	DGP30	G	SUPERRECTIFIER® Axial	DO-201AD	1500	1.2	3.0
	GP30y	G	SUPERRECTIFIER® Axial	DO-201AD	50 - 1000	1.1 / 1.2	3.0
	G3y	G → T	Sinterglass Axial	G3	50 - 1000	1.1 / 1.2	3.0
	G4y	G → T	Sinterglass Axial	G4	50 - 600	1.1	3.0
	GI500-GI510	G	Plastic Axial	DO-201AD	50 - 1000	1.1	9.4
	P300y	G	Plastic Axial	DO-201AD	50 - 1000	1.2	3.0
S3y	G	Plastic SMD ⁽²⁾	DO-214AB (SMC)	50 - 1000	1.15	2.5	
4.0	S4PB - S4PM	G	Plastic SMD	TO-277A (SMPC)	100 - 1000	1.10	4.0
5.0	S5y	G	Plastic SMD ⁽²⁾	DO-214AB (SMC)	50 - 1000	1.15	5.0
6	GI750-GI758	G	Plastic Axial	P600	50 - 800	0.9 / 0.95	6.0
	GPP60y	G	Plastic Axial	P600	50 - 400	1.1	6.0
	P600y	G	Plastic Axial	P600	50 - 1000	0.9 / 1.0	6.0
8.0	NS8yT	G	Plastic Power Pack ⁽²⁾	TO-220AC	50 - 1000	1.1	8.0
	NSB8yT	G	Power Pack SMD ⁽²⁾	TO-263AB (D ² PAK)	50 - 1000	1.1	8.0
	NSF8yT	G	Isolated Power Pack ⁽²⁾	ITO-220AC	50 - 1000	1.1	8.0

ESD Protection Rectifiers

I _{F(AV)} (A)	Device ⁽¹⁾	Source ⁽³⁾	Package		V _(BR) Range (V)	Max V _F @ I _F	
			Family	Type		(V)	(A)
0.7	SE07Py	G	Plastic SMD ⁽²⁾	DO-220AA (SMP)	100 - 600	1.05	0.7
1.0	SE10Py	G	Plastic SMD ⁽²⁾	DO-220AA (SMP)	100 - 600	1.05	1.0
1.5	SE15Py	G	Plastic SMD ⁽²⁾	DO-220AA (SMP)	100 - 600	1.05	1.5

Notes:

(1) **Bold Text** = New Products

"x" designates a number that indicates voltage or is part of a sequence

"y" designates reverse voltage, where:

A=50 V C=150 V F=300 V H=500 V K=800 V

B=100 V D=200 V G=400 V J=600 V M=1000 V

(2) Glass passivated die

(3) Source: G = Formerly General Semiconductor®

T = Formerly Vishay Telefunken® (Telefunken® is a registered trademark of Electro Holding GMBH)

→ = Transferred

Bridge Rectifiers are essential for any electronic equipment which requires full wave rectification of an AC power source. The bridge rectifier is comprised of four separate rectifier components configured into a “bridge” arrangement in a single package. Vishay manufactures a complete line of bridge rectifiers including fast recovery, surface-mount, and single in-line types.

I _{F(AV)} (A)	Device ⁽¹⁾	Source ⁽⁷⁾	Package		V _(BR) Range (V)	Max V _F ⁽⁵⁾ @ I _F	
			Family	Type		(V)	(A)
0.5	MBxM	G	Mini-bridge	MBM	200 - 600	1.0	0.4
	BxM	G	Mini-bridge	MBM	200 - 600	1.0	0.5
	MBxS	G	Mini-bridge (SMD)	MBS (TO-269AA)	200 - 600	1.0	0.4
	BxS	G	Mini-bridge (SMD)	MBS (TO-269AA)	200 - 600	1.0	0.5
	RMBxS	G	Recovery mini-bridge (SMD)	MBS (TO-269AA)	200 - 400	1.25	0.4
0.9	BxxC800DM	G	Dual in-line	DFM	65 - 600	1.0	0.9
	BxxC800G	G	WOG	WG	65 - 600	1.0	0.9
1.0	BxxC1000G	G	WOG	WG	65 - 600	1.0	1.0
	DFxxM	G	Dual in-line	DFM	50 - 1000	1.1	1.0
	DFxxMA	G	Dual in-line	DFM	50 - 1000	1.1	1.0
	DFxxS	G	Dual in-line (SMD)	DFS	50 - 1000	1.1	1.0
	DFxxSA	G	Dual in-line (SMD)	DFS	50 - 1000	1.1	1.0
	EDF1yM	G	Ultrafast dual in-line ⁽³⁾	DFM	50 - 200	1.05	1.0
	EDF1yS	G	Ultrafast dual in-line (SMD) ⁽³⁾	DFS	50 - 200	1.05	1.0
1.5	3N24x	G	Single in-line	KBPM	50 - 1000	1.0 / 1.3	1.0 / 1.57
	BxxC1500G	G	WOG	WG	65 - 600	1.0	1.5
	DF15xxS	G	Dual in-line (SMD)	DFS	50 - 1000	1.1	1.5
	DFL15xxS	G	Low-profile DIL (SMD)	L-DFS	50 - 1400	1.1	1.5
	G2SBxx	G	Single in-line ⁽⁴⁾	GBL	200 - 800	1.05	0.75
	G2SBAxx	G	Single in-line ⁽⁴⁾	GBL	200 - 800	1.05	0.75
	KBPxxM	G	Single in-line	KBPM	50 - 1000	1.0 / 1.3	1.0 / 1.57
2.0	WxxG	G	WOG	WG	50 - 1000	1.0	1.0
	2KBPxxM	G	Single in-line	KBPM	50 - 1000	1.1	3.14
	2WxxG	G	WOG	WG	50 - 1000	1.1	2.0
3.0	3N25x	G	Single in-line	KBPM	50 - 1000	1.1	3.14
	GBPC1xx	G	GBPC with wire leads	GBPC1	50 - 1000	1.0	1.5
	3KBPxxM	G	Single in-line	KBPM	50 - 800	1.05	3.0
4.0	G3SBAxx	G	Single in-line with mounting hole ⁽⁴⁾	GBU	200 - 600	1.0	2.0
	GBLxx	G	Single in-line	GBL	50 - 1000	1.1	4.0
	GBLAxx	G	Single in-line	GBL	50 - 1000	1.1	4.0
	GBU4y	G	Single in-line with mounting hole	GBU	50 - 1000	1.0	4.0
	GSIB4xx	G	Single in-line with mounting hole	GSIB-3G	200 - 800	0.95	2.0
	GSIB4Axx	G	Single in-line with mounting hole	GSIB-3G	200 - 800	1.0	2.0
	KBLxx	G	Single in-line*	KBL	50 - 1000	1.1	4.0
	KBU4y	G	Single in-line with mounting hole*	KBU	50 - 1000	1.0	4.0

Notes:

(1) **Bold Text** = New Products

(2) All bridges use glass passivated chips, unless designated with*

(3) t_r = 50 ns max. for EDF1 types

(4) Japanese electrical specifications

(5) V_F limits are per leg

(6) Bridges are UL listed under Recognized Component Index, file number E54214

(7) Source: G = Formerly General Semiconductor®

T = Formerly Vishay Telefunken® (Telefunken® is a registered trademark of Electro Holding GMBH)

→ = Transferred



I _{F(AV)} (A)	Device ⁽¹⁾	Source ⁽⁷⁾	Package		V _(BR) Range (V)	Max V _F ⁽⁵⁾ @ I _F		
			Family	Type		(V)	(A)	
6.0	GBPC6xx	G	GBPC with wire leads		GBPC6	50 - 1000	1.0	3.0
	GBU6y	G	Single in-line with mounting hole		GBU	50 - 1000	1.0	6.0
	G5SBAxx	G	Single in-line with mounting hole ⁽⁴⁾		GBU	200 - 600	1.05	3.0
	GSIB6xx	G	Single in-line with mounting hole		GSIB-5S	200 - 800	0.95	3.0
	GSIB6Axx	G	Single in-line with mounting hole		GSIB-5S	200 - 800	1.0	3.0
	KBU6y	G	Single in-line with mounting hole*		KBU	50 - 1000	1.0	6.0
8.0	GBU8y	G	Single in-line with mounting hole		GBU	50 - 1000	1.0	8.0
	KBU8y	G	Single in-line with mounting hole*		KBU	50 - 1000	1.0	8.0
10	BU10xx	G	Single in-line with mounting hole		BU	600 - 1000	1.05	5.0
	BU10xxA	G	Single in-line with mounting hole		BU	600 - 1000	1.1	5.0
	VSIB10Axx	G	Single in-line with mounting hole		GSIB-5S	200 - 800	1.0	5.0
12	BU12xx	G	Single in-line with mounting hole		BU	600 - 1000	1.05	6.0
	GBPC12xx	G	GBPC with fast-on lugs		GBPC12-35	50 - 1000	1.1	6.0
	GBPC12xxW	G	GBPC with wire leads		GBPC12-35W	50 - 1000	1.1	6.0
15	BU15xx	G	Single in-line with mounting hole		BU	600 - 1000	1.05	7.5
	GBPC15xx	G	GBPC with fast-on lugs		GBPC12-35	50 - 1000	1.1	7.5
	GBPC15xxW	G	GBPC with wire leads		GBPC12-35W	50 - 1000	1.1	7.5
	GSIB15xx	G	Single in-line with mounting hole ⁽⁴⁾		GSIB-5S	200 - 800	0.95	7.5
	GSIB15Axx	G	Single in-line with mounting hole ⁽⁴⁾		GSIB-5S	200 - 800	1.05	7.5
	VSIB15xx	G	Single in-line with mounting hole ⁽⁴⁾		GSIB-5S	200 - 800	0.95	7.5
	VSIB15Axx	G	Single in-line with mounting hole ⁽⁴⁾		GSIB-5S	200 - 800	1.0	7.5
20	BU20xx	G	Single in-line with mounting hole		BU	600 - 1000	1.05	10
	GSIB20xx	G	Single in-line		GSIB-5S	200 - 800	1.1	10
	VSIB20xx	G	Single in-line with mounting hole ⁽⁴⁾		GSIB-5S	200 - 800	1.0	10
25	BU25xx	G	Single in-line with mounting hole		BU	600 - 800	1.05	12.5
	GBPC25xx	G	GBPC with fast-on lugs		GBPC12-35	50 - 1000	1.1	12.5
	GBPC25xxW	G	GBPC with wire leads		GBPC12-35W	50 - 1000	1.1	12.5
	GSIB25xx	G	Single in-line		GSIB-5S	200 - 800	1.05	12.5
	VSIB25xx	G	Single in-line with mounting hole ⁽⁴⁾		GSIB-5S	200 - 800	1.0	12.5
35	GBPC35xx	G	GBPC with fast-on lugs		GBPC12-35	50 - 1000	1.1	17.5
	GBPC35xxW	G	GBPC with wire leads		GBPC12-35W	50 - 1000	1.1	17.5

Notes:

- (1) **Bold Text** = New Products
- (2) All bridges use glass passivated chips, unless designated with*
- (3) t_{rr}=50 ns max. for EDF1 types
- (4) Japanese electrical specifications
- (5) V_F limits are per leg
- (6) Bridges are UL listed under Recognized Component Index, file number E54214
- (7) Source: G = Formerly General Semiconductor®
T = Formerly Vishay Telefunken® (Telefunken® is a registered trademark of Electro Holding GMBH)
→ = Transferred

Rectifiers Selector Guide



Rectifier Packages

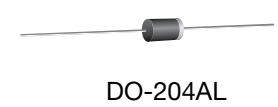
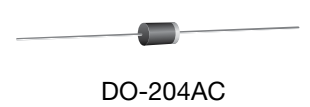
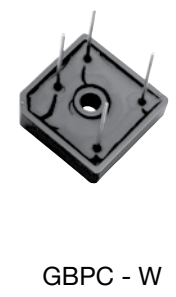
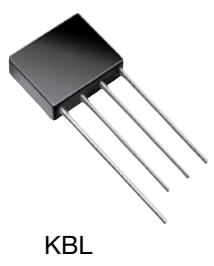
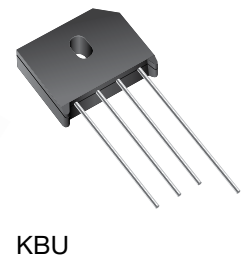
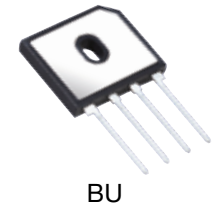
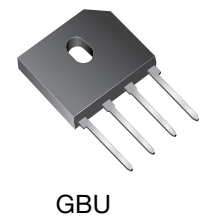
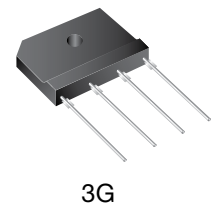
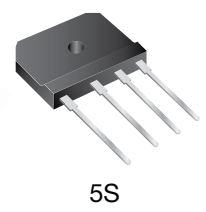
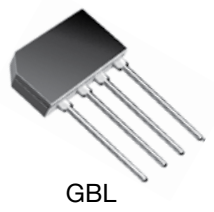
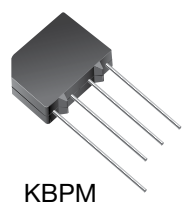
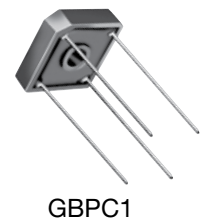
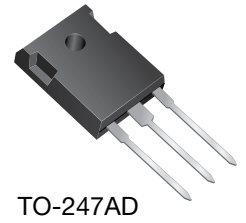
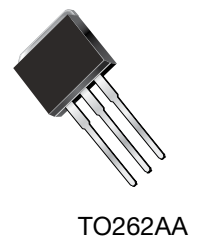
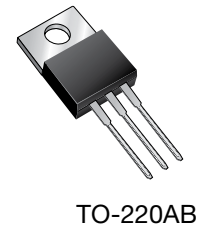
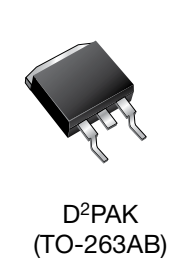
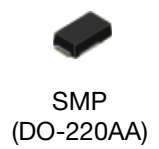

SUPERRECTIFIER®

The SUPERRECTIFIER is exactly that: a super rectifier. This highly-reliable and cost-effective rectifier is the result of a combination of patented technologies. No other 0.25-A to 3.0-A rectifiers of any kind — plastic, glass, or metal — can match the SUPERRECTIFIER combination of features that result from Vishay's unique glass-plastic construction. SUPERRECTIFIER products are offered in standard, fast, and ultrafast types for both axial and surface mounting.

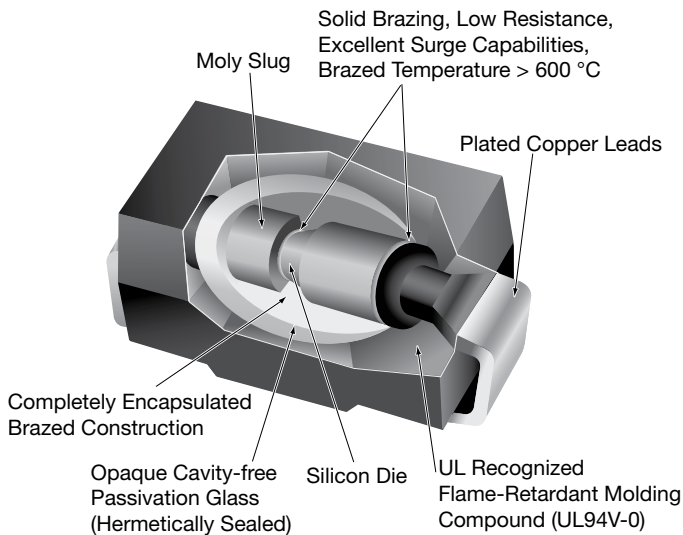

SINTERGLASS RECTIFIER

The glass passivated rectifier is a hermetically-sealed, diffused junction rectifier with unsurpassed operating and surge capabilities at high temperatures. An extremely pure, specially developed glass applied in direct contact with the silicon junction, creates an ideal cavity-free passivating medium. Glass rectifiers are offered in standard, fast, and ultrafast types.

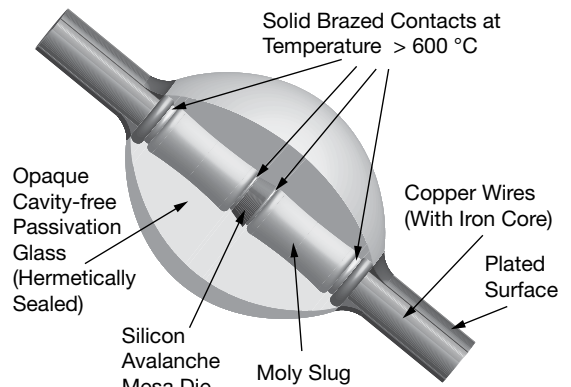

ITO-220AB

Vishay offers the TO-220 power package with either the heat sink exposed or with an isolated body, as shown below.

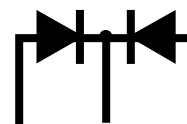
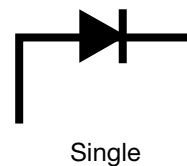
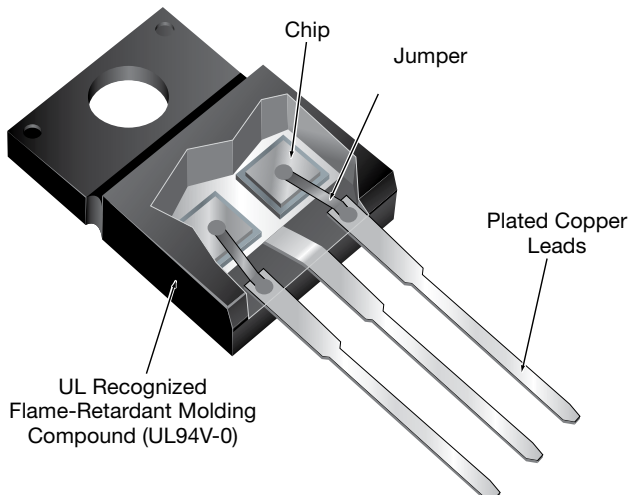



Notes



Notes



Notes



SEMICONDUCTORS:

Rectifiers • High-Power Diodes and Thyristors • Small-Signal Diodes • Zener and Suppressor Diodes
• FETs • RF Transistors • Optoelectronics • ICs • Modules and Assemblies

PASSIVE COMPONENTS:

Resistive Products • Magnetics • Capacitors • Strain Gage Transducers and Stress Analysis Systems

**One of the World's Largest
Manufacturers**
of Discrete Semiconductors and Passive Components

WORLDWIDE SALES CONTACTS

THE AMERICAS

UNITED STATES

VISHAY AMERICAS
ONE GREENWICH PLACE
SHELTON, CT 06484
UNITED STATES
PH: +1-402-563-6866
FAX: +1-402-563-6296

ASIA

SINGAPORE

VISHAY INTERTECHNOLOGY
ASIA PTE LTD.
25 TAMPINES STREET 92
KEPPEL BUILDING #02-00
SINGAPORE 528877
PH: +65-6788-6668
FAX: +65-6788-0988

P.R.C.

VISHAY TRADING (SHANGHAI) CO., LTD.
(SHANGHAI REPRESENTATIVE OFFICE)
ROOM D,15F, SUN TONG INFOPORT PLAZA
55 HUAI HAI WEST ROAD
200030 SHANGHAI
P.R.C.
PH: +86-21-5258-5000
FAX: +86-21-5258-7979

JAPAN

VISHAY JAPAN CO., LTD.
MG IKENOHATA BLDG. 4F
1-2-18, IKENOHATA
TAITO-KU
TOKYO 110-0008
JAPAN
PH: +81-3-5832-6210
FAX: +81-3-5832-6260

EUROPE

GERMANY

VISHAY ELECTRONIC GMBH
GEHEIMRAT-ROSENTHAL-STR. 100
95100 SELB
GERMANY
PH: +49-9287-71-0
FAX: +49-9287-70435

FRANCE

VISHAY S.A.
199, BLVD DE LA MADELEINE
06003 NICE, CEDEX 1
FRANCE
PH: +33-4-9337-2920
FAX: +33-4-9337-2997

NETHERLANDS

VISHAY BCCOMPONENTS B.V.
HURKESTRAAT 31
P.O. BOX 8766
5652 AH EINDHOVEN
NETHERLANDS
PH: +31-40-2590-700
FAX: +31-40-2590-777